

Residential Sprinkler System Design Handbook

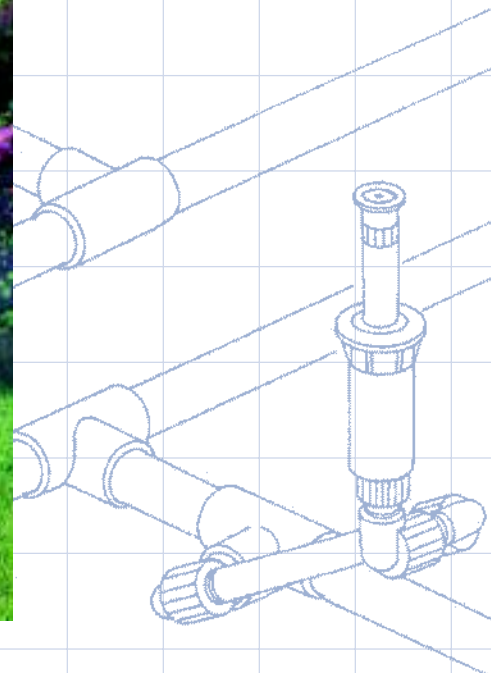

A Step-By-Step
Introduction to
Design and Installation

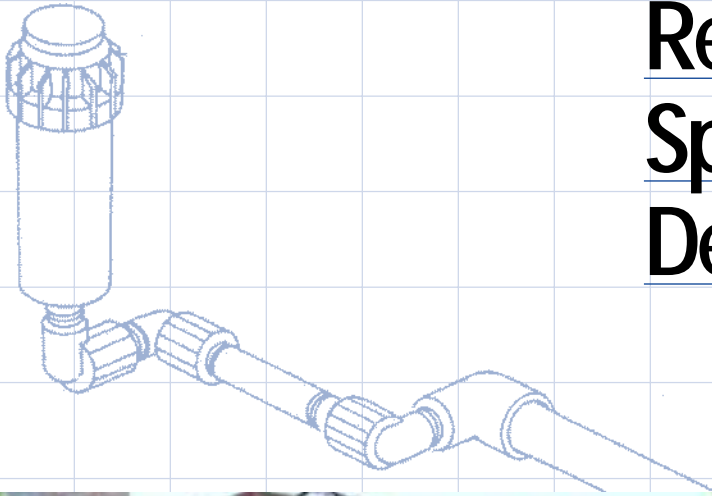
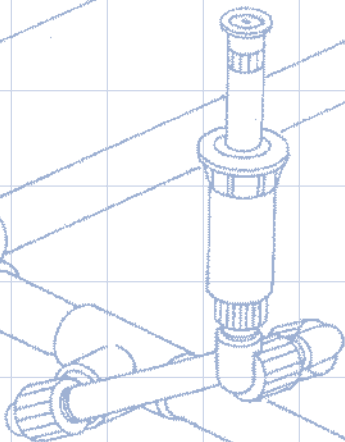

Hunter[®]
The Irrigation Innovators

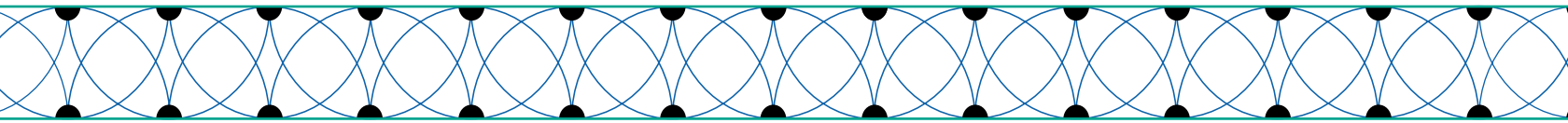

This booklet is intended to be used when designing and installing small single family residential sprinkler systems. It is set up in an easy-to-follow format with illustrations and helpful charts.

If this is the first system you have installed, or if you have installed several systems but have never used this guide before, we recommend you look through the next few pages and become familiar with this presentation of the design and installation process.

You will notice we have included a sheet of graph paper for your convenience. There are detailed illustrations depicting suggested installation methods for sprinkler heads, pipe and valve manifolds, and how to connect the sprinkler main line into the house water system. Installation tips have also been placed throughout the guide to assist you in planning a system. A Glossary of Terms is included and Hunter Sprinkler Performance Charts are featured on the back cover.

While developing the Gallons Per Minute (GPM), Working Pressure and Pipe Sizing charts, we considered reasonable friction loss and acceptable water velocity for a residential irrigation system. If you have any questions on the design or installation process, your best resource is your local Hunter distributor.

Hunter recommends contracting the services of a professional irrigation designer when planning large residential or commercial projects. Contractors and irrigation designers can receive additional information by contacting their local Hunter distributor.



Contents

Plot Plan and Design	1
Sprinkler System Design Capacity	2
<i>Service Line Size Chart</i>	
<i>System Design Capacity Chart</i>	
Select Sprinkler Heads	3
Locating Sprinkler Heads	4
Divide Sprinklers Into Zones	5
<i>Area Capacity Example</i>	
Locate Valves and Size Pipes	6
<i>Pipe Sizing Chart</i>	
Point of Connection	7
Sprinkler System Overview	8–9
System Installation	10–12
<i>Making the Point of Connection</i>	
<i>Installing the Main Line</i>	
<i>Installing the Valve Manifolds</i>	
<i>Installing the Lateral Lines</i>	
<i>Installing the Controller</i>	
<i>Installing Heads</i>	
<i>Backfilling</i>	
Materials List	13–15
Glossary of Terms	16
Watering Guidelines	Inside Back Cover
Sprinkler Performance Charts	Back Cover

Hunter[®]
The Irrigation Innovators

1940 Diamond Street, San Marcos, California 92069, U.S.A.
Telephone: (1) 760-744-5240 • Fax: (1) 760-744-7461
Internet: www.HunterIndustries.com

Plot Plan and Design

A. Plot Plan And Design

1. The first step in designing a residential system is to measure the property and indicate the location of the house. On a separate piece of paper sketch out your property and place your measurements on the sketch.

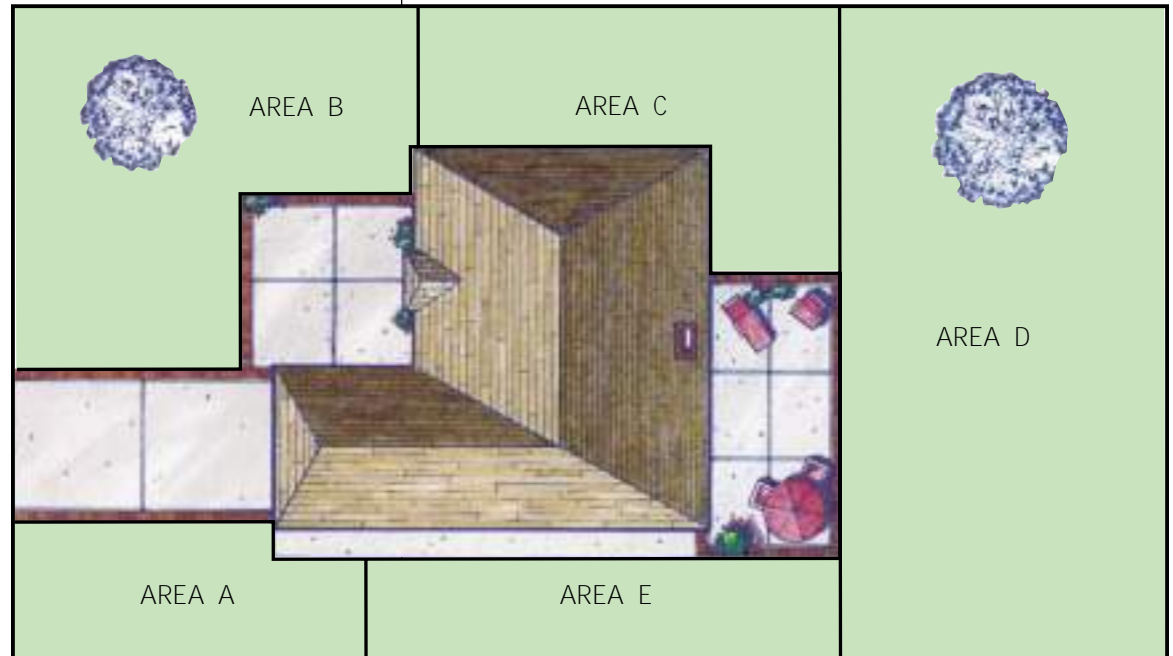

Graph Areas

Be sure to include all concrete or brick walks and patios, driveways and fences. While you are measuring, locate any trees, shrubs and lawns and draw them on the sketch.

2. Next, draw the plot plan to scale on the graph paper provided. The scale can be 1" = 10', 1" = 20', or whatever you decide. Write your scale on the plan. Make sure to note lawn, shrub, ground cover and large trees.

3. On the plot plan, divide the property into areas. The areas should be rectangles or squares and as large as possible. Consider the information in Step 2 above while dividing up the plot plan: front yard, back yard and side yard, lawn or shrub areas and shady areas. Label your areas A, B, C, D, etc. (See the example plot plan above.)



TIP

Tools and Supplies You Will Need

Permit	Automatic Drain Valve
Electrical Tape	(Used in freezing climates to winterize system)
Hack Saw	Insulated Wire Staples
Hammer	Rain Shut-off Device
Pipe Wrenches	Shut-off Valves
Plastic Tarp	Teflon Tape
Pliers	(Used on all PVC or Poly thread-to-thread fittings)
Rags	Valve Boxes, 6" and 12"
Rake	
Screwdriver	
Small Irrigation Flags	
Shovels - Trenching, Flat, Spade or Round Point	If you use PVC Pipe:
Spray Marking Paint	Glue (Solvent)
Tape Measure	Primer
Trencher or Pipe-Puller	PVC Pipe Cutters
Tunnel Kit or	
Hose Jetting Kit	If you use Poly Pipe:
Wire Cutters	Pipe Clamps

Sprinkler System Design Capacity

B. Determine System Design Capacity

When planning an efficient automatic irrigation system, you must first determine the correct Sprinkler System Design Capacity — how much water is available for residential irrigation. If the system will be installed using the city water, follow the steps below. If the water will be drawn from a lake or well, your Hunter dealer or the pump installer will have the specifications for pressure and volume

1. Water pressure (PSI)

To check the water pressure, attach a pressure gauge to the outside faucet closest to the water meter. Make sure that no other water is flowing at the residence. Turn on the faucet and record the number in the area provided to the right. This is the static water pressure in pounds per square inch or PSI.

2. Water volume (GPM)

To determine the volume of water available for the system, you need two pieces of information:

A. What size is the water meter?

Water meters will generally have the size stamped on the meter body. The most common sizes for residential meters are 5/8", 3/4", and 1". In some areas the water supply hooks directly into the city main without the use of the water meter. In these cases, simply enter the size of the service line in the space provided.

B. What size is the service line?

Measure the outside circumference of the pipe that runs from the city main to the house. An easy way to do that is to wrap a piece of string around the pipe, measure the string, and use the table to the right to convert the string length to pipe size.

3. System Design Capacity

Using the System Design Capacity Chart on this page, locate the three numbers you just recorded to determine the Sprinkler System Design Capacity in gallons per minute (GPM). Record this number in the GPM box. Next, locate your system's static pressure and move down that column and find the system's working pressure; record it in the PSI box. Working pressure will be used when choosing sprinkler heads and designing the system.

You have now established the maximum GPM and the approximate working pressure available for the sprinkler system. Exceeding these maximums may result in inefficient watering or a condition referred to as water hammer, which could cause serious damage to the system. These two numbers will be used in the design process.



To check water pressure, attach a pressure gauge to the outside faucet nearest the water meter. A pressure gauge can be obtained from your local Hunter dealer.

Enter Static Pressure Here: _____

Enter the Size of the Meter Here: _____

Write the Service Line Size Here: _____

SERVICE LINE SIZE						
APPROXIMATE STRING LENGTH	2 3/4"	3 1/4"	3 1/2"	4 1/8"	4 3/8"	5 1/4"
Size of Copper Pipe	3/4"		1"		1 1/4"	
Size of Galvanized Pipe		3/4"		1"		1 1/4"
Size of PVC Pipe		3/4"		1"		1 1/4"

SPRINKLER SYSTEM DESIGN CAPACITY							
STATIC PRESSURE		30	40	50	60	70	80
WATER METER	SERVICE LINE	MAX GPM	MAX GPM	MAX GPM	MAX GPM	MAX GPM	MAX GPM
5/8"	1/2"	2	4	5	6	7	7
	3/4"	4	6	8	8	10	12
	1"	4	7	8	10	13	15
3/4"	3/4"	4	6	8	9	10	12
	1"	5	7	10	14	17	20
	1-1/4"	5	12	17	20	22	22
1"	3/4"	4	7	8	9	12	12
	1"	5	8	14	18	20	20
	1-1/4"	5	14	24	26	30	34
Working Pressure		25	30	35	45	50	55

Service lines are based on 100' of Sch 40 PVC. Deduct 2 GPM for copper pipe. Deduct 5 GPM for new galvanized pipe.

Working pressure is the approximate working pressure at the head, and should be used only as a guide when choosing the proper sprinkler heads and designing the system. The numbers in the Design Capacity Chart are based on generally accepted flow rates (velocity). In some cases, designers increase the velocity in copper pipe only from the accepted 7 1/2 feet per second (fps) to 9 feet per second (fps). If you do not deduct the 2 GPM for copper pipe, the rate is approximately 9 feet per second (fps). The friction loss is substantially increased at this speed, and the working pressure will be affected. In order to use the numbers in the chart, the length of copper service line should not exceed 50' if you decide not to deduct the 2 GPM.

GPM

Design Capacity

PSI

Working Pressure

Select Sprinkler Heads

C. Select Sprinkler Heads

There are two basic types of sprinklers for residential use: large area rotors and small area sprinklers. Large area rotors should never be installed on the same zone as small area sprinklers.

Locate Sprinklers

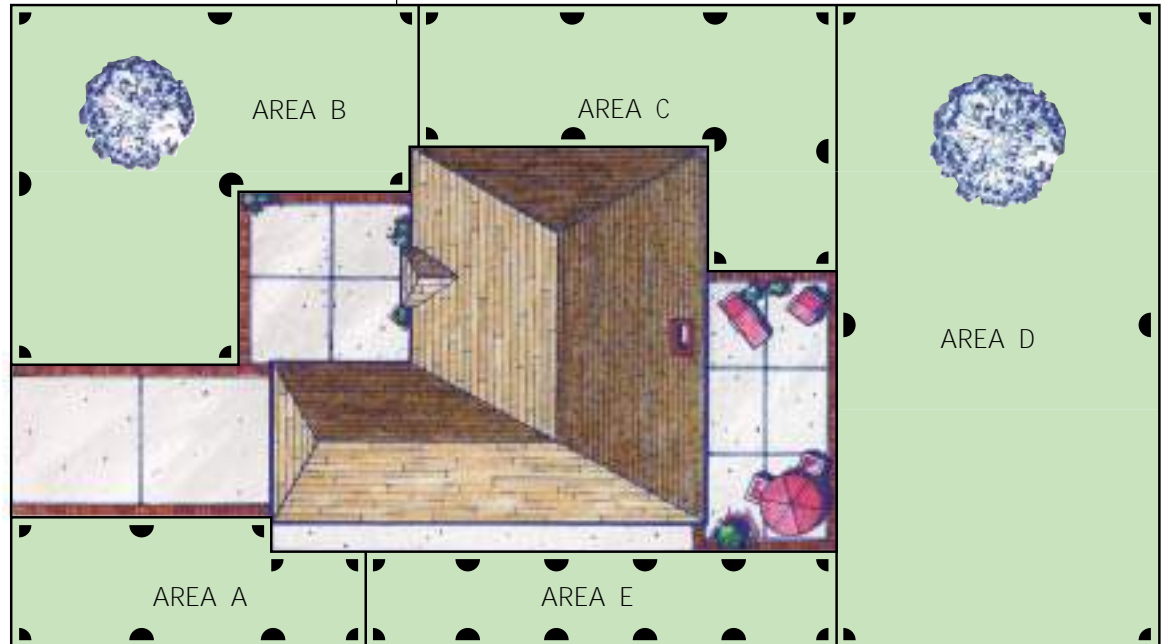

1. Large area rotors will cover areas that measure 25' by 25' and larger.
2. Small area sprinklers are typically used in areas smaller than 25' by 25'.

Within both of these groups are pop-up sprinklers which are installed even with the grade, and riser-mounted shrub heads, which are installed above grade.

This 25' by 25' measurement is not a hard rule, rather it is a guideline. The only consideration restricting the size of the area in which spray heads (small area sprinklers) can be used is economics. If a large area rotor can be used, it usually means less pipe, fewer valves and a smaller controller will be required to complete the job.

EXAMPLE

System Design Capacity

- ▶ Water Meter 5/8"
- ▶ Service Line 1"
- ▶ Static Pressure 70 PSI

According to System Design Capacity

13 GPM

Design Capacity

50 PSI

Working Pressure



*Pro-Spray – Small Area Spray
8' to 17' spacing*



*PGM – Mid-Range Rotor
17' to 25' spacing*



*PGM – Large Area Rotor
25' to 40' spacing*



*I-20 Ultra – Large Area Rotor
25' to 40' spacing*

Locating Sprinkler Heads

D. Draw Sprinkler Head Locations

Decide where you will be installing large area sprinklers and where you will be installing small area sprinklers. Large area sprinklers should be 25' to 40' apart. Small area sprinklers should be 8' to 17' apart. This spacing will allow sprinklers to overlap their throw to assure even water distribution. Do not mix sprinkler types within one area.

Do not place sprinkler heads too far apart; stay within specifications listed on the Sprinkler Performance Charts on the back cover. Spacing is determined by the size of the area the sprinkler is serving. Additionally, a sprinkler should be spaced so that it will spray both the head next to it and the head across from it. Working with one area at a time, start placing sprinkler heads:

Step 1. The critical points on a plan are the corners.

Draw a quarter pattern sprinkler in each corner. Using a compass, draw an arc showing the sprinkler's watering pattern.

Step 2. If the quarter heads will not spray each other (head-to-head spacing), place heads along the perimeters. Draw these sprinklers' watering patterns.

Step 3. Now look to see if the perimeter heads will be spraying across the area to the heads on the other side.

If they do not, add full circle heads in the middle. An easy way to locate these heads is to draw perpendicular grid lines from one perimeter head to another. Again, using the compass, draw an arc showing this sprinkler's watering pattern to make sure there is complete coverage.

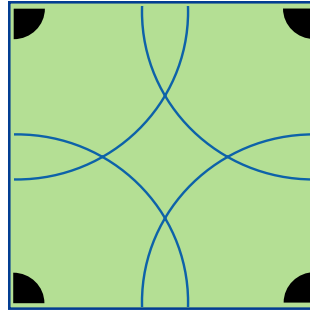

Step 1

Corners are critical points. Start by placing sprinklers in each corner.

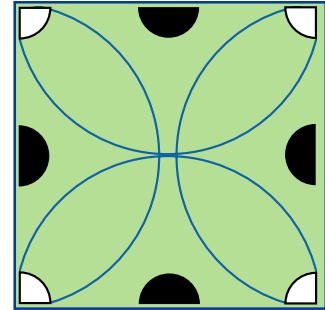

Step 2

Add sprinklers along the sides if necessary.

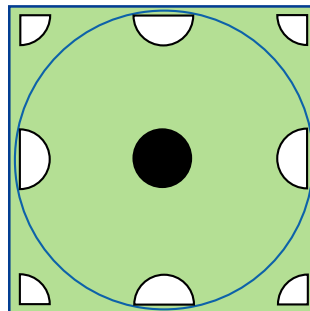

Step 3

Larger areas may require sprinklers in the middle, in addition to the

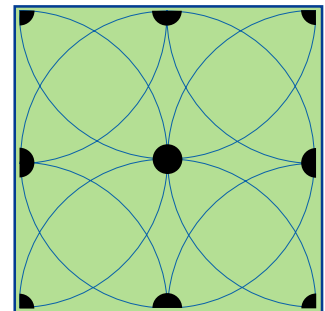

sides, in order to provide head-to-head or overlapping coverage.

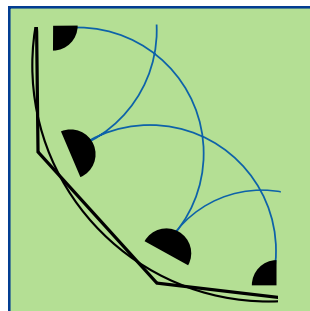

Curved Areas

Convert curved areas to a series of straight lines; place sprinklers the same as you would in square or

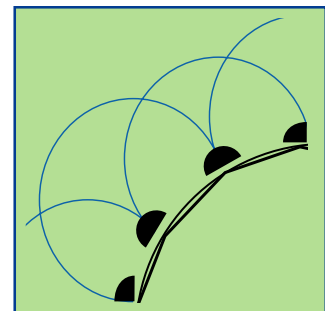

rectangular areas. Adjustable arc nozzles on spray heads work very well in curved areas.

TIP

- Check with local agencies:
- To find out if a permit is required before installing a sprinkler system.
 - To determine where gas, telephone and other utility lines are buried.
 - To find out which type of backflow preventer is required in your area.

Divide Sprinklers Into Zones

E. Divide Sprinklers Into Zones

Unless you have a very small yard, you probably do not have enough water capacity to irrigate the entire yard at once. Many areas will require more water than the residence has available (system design capacity).

Indicate Zones

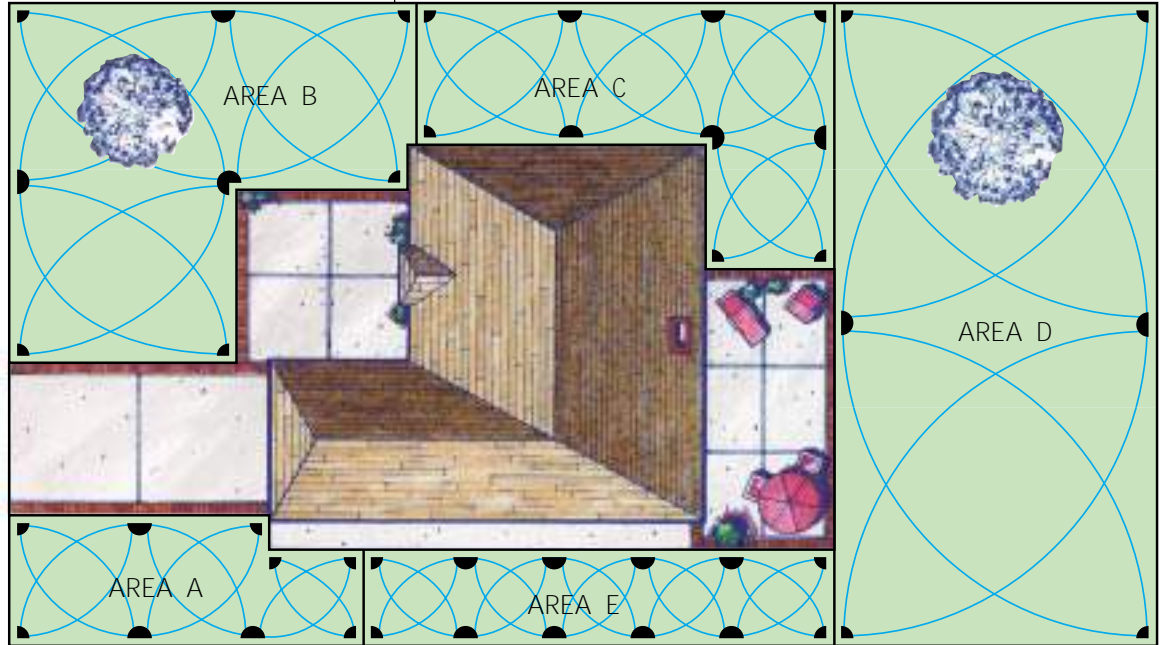

You will need to section the yard into “zones.” Dividing the area into zones is an easy process. Beginning with area A:

1. Refer back to the working pressure entered on page 2. This is the pressure you will need to use when determining sprinkler spacing and GPM requirements listed in the Sprinkler Performance Charts.
2. Write the individual sprinkler’s GPM next to each sprinkler head in the area. Use the Sprinkler Performance Charts on the back cover.
3. Add up all of those numbers and divide the sum by the total GPM (system design capacity) available.
4. If the total number of zones is not a whole number, round the number up to establish how many zones there will be (1.2 zones becomes 2 zones). This is the total number of valves needed for the sprinklers in that area.
5. Now that you know how many zones the area will have, divide up the sprinklers so that each zone in the area will have approximately the same GPM. Do not place too many heads on the same zone; stay within the system’s design capacity.
6. Draw and label the zone valves for this area, i.e. Zone 1, Zone 2, etc.
7. Repeat steps D and E for all areas.

$$\begin{array}{ccc}
 \boxed{} & \div & \boxed{} = \boxed{} \\
 \text{Total GPM of all heads} & & \text{Design capacity in GPM} & & \text{Number of zones in} \\
 \text{in one area} & & \text{(from page 2)} & & \text{this area}
 \end{array}$$

AREA CAPACITY EXAMPLE					
Area	Area GPM	÷	Design Capacity	=	Round up for Number of Zones
A	4.68	÷	13	=	1
B	12.00	÷	13	=	1
C	16.00	÷	13	=	2
D	16.00	÷	13	=	2
E	7.80	÷	13	=	1



Locate Valves and Size Pipes

F. Locate Valves • Layout and Size Pipes

Every zone on the plot plan must have its own valve. The valve controls the on-off flow of water to a sprinkler zone. Indicate one control valve for each zone and then group the valves together in an assembly called a valve manifold.

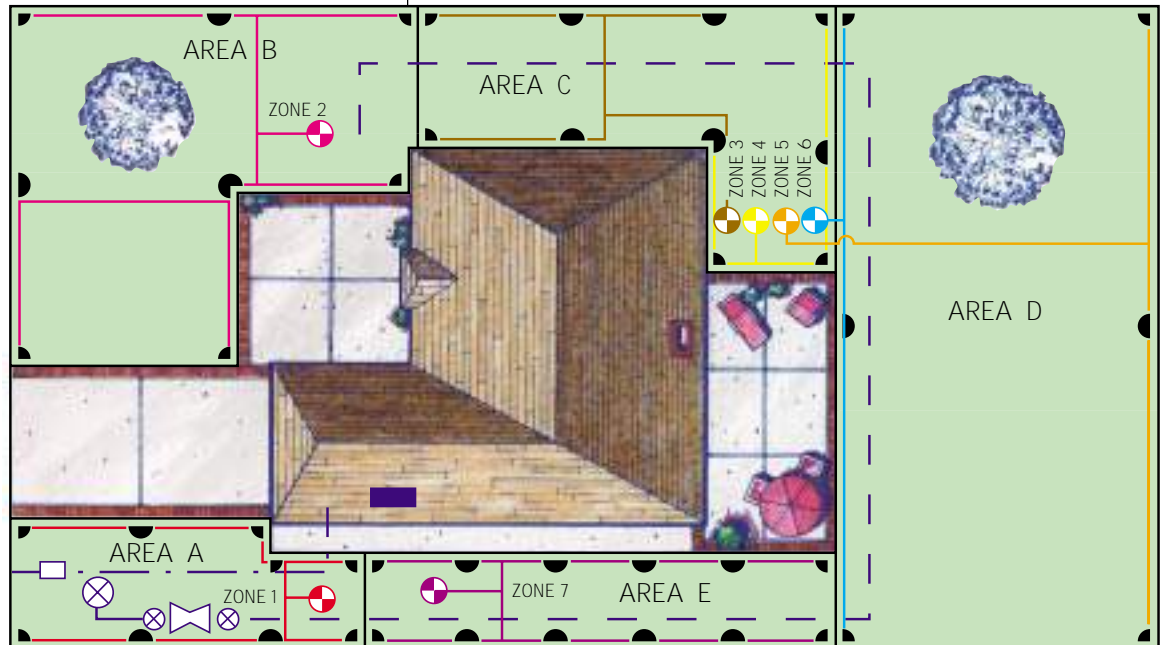

Valves and Pipe

Determine where you want the valve manifold for each area. You may want a manifold in the front yard and one in the back yard, or you may want more locations. Manifold placement is entirely up to you. We recommend placing the manifold in an accessible spot for easy maintenance. Place the manifold close to the area the valves will serve, but where you will not be sprayed when activating the system manually.

Lateral Line

The two most common types of pipe used in sprinkler systems are polyvinyl chloride (PVC) and polyethylene (Poly). Check with your local Hunter dealer to find out which type of pipe is used in your area.

1. Draw a line connecting all of the sprinkler heads in each separate zone. Follow the example in the illustration on this page and draw the most direct route with the fewest turns or changes of direction as possible.
2. Draw a line from the sprinkler line to the zone valve. This should be the most direct line possible.
3. Begin sizing the pipe. Start at the head farthest from the zone valve. The pipe connecting the last head to the second to last head should be 3/4." (See Pipe Sizing Chart.)



PIPE SIZING CHART					
Maximum Flow Rates for Sprinkler Lines					
PVC Schedule 40		PVC Class 200		Polyethylene Pipe	
3/4"	8 GPM	3/4"	10 GPM	3/4"	8 GPM
1"	13 GPM	1"	16 GPM	1"	13 GPM
1 1/4"	22 GPM	1 1/4"	26 GPM	1 1/4"	22 GPM

Connecting Sprinklers with PVC or Poly Pipe

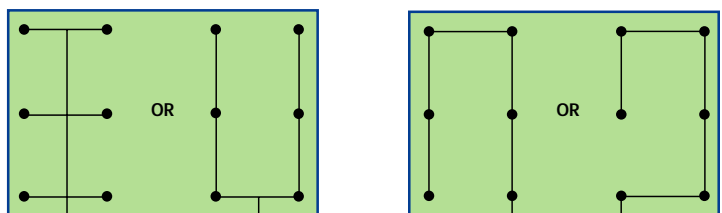

RIGHT

WRONG

Point of Connection

4. Add the GPM requirements of those two heads together to size the next pipe.
5. Add the GPM requirements of the next head to the previous total.
6. Continue to do this until you get to the zone valve. Be sure not to size a pipe smaller than the chart indicates.
7. Repeat Steps 1 through 6 for each zone.

Main Line

1. Determine the location for the system point of connection (P.O.C.). It should be near the water meter.
2. Draw a line connecting all the manifolds together, and then draw a line connecting this line to the P.O.C.
3. The main line should be one pipe size larger than the largest lateral line.

G. Point Of Connection

Non-Freezing Climates

Use a brass compression tee to hook your sprinkler system to the household water supply line. You may hook up to copper, PVC or galvanized iron service lines without having to solder or thread any pipe.

Most areas require some type of backflow preventer to protect drinking water. Copper pipe may be required between the P.O.C. and the backflow preventer. Always check the local building code or with the local permitting agency for the requirements in your area.

Freezing Climates

If the installation is in a freezing climate and the P.O.C. is in the basement, install a boiler drain immediately after the gate valve to drain the water in the pipe between the P.O.C. and the backflow preventer in the winter.

Install a slip x slip x 1 inch threaded tee with a riser and a threaded cap after the backflow preventer. This will be used when blowing out the system before the first deep freeze of winter.

Review Design

The design process is now complete. Check to make sure you have placed sprinklers in all areas. Also, review the pipe layout to be sure you have sized the pipe correctly. You are now ready to begin installing the system.



P.O.C. Non-Freezing: Use a brass compression tee to connect your sprinkler system to the household water supply.



P.O.C. Freezing Climate: If the P.O.C. is in the basement, install a boiler drain immediately after the gate valve to drain the system before the first big freeze.

TIP

Most professional installers recommend PVC pipe for the constant pressure line from the backflow preventer to the zone control valves. Some communities require copper, however. Check local ordinances before laying out your system.

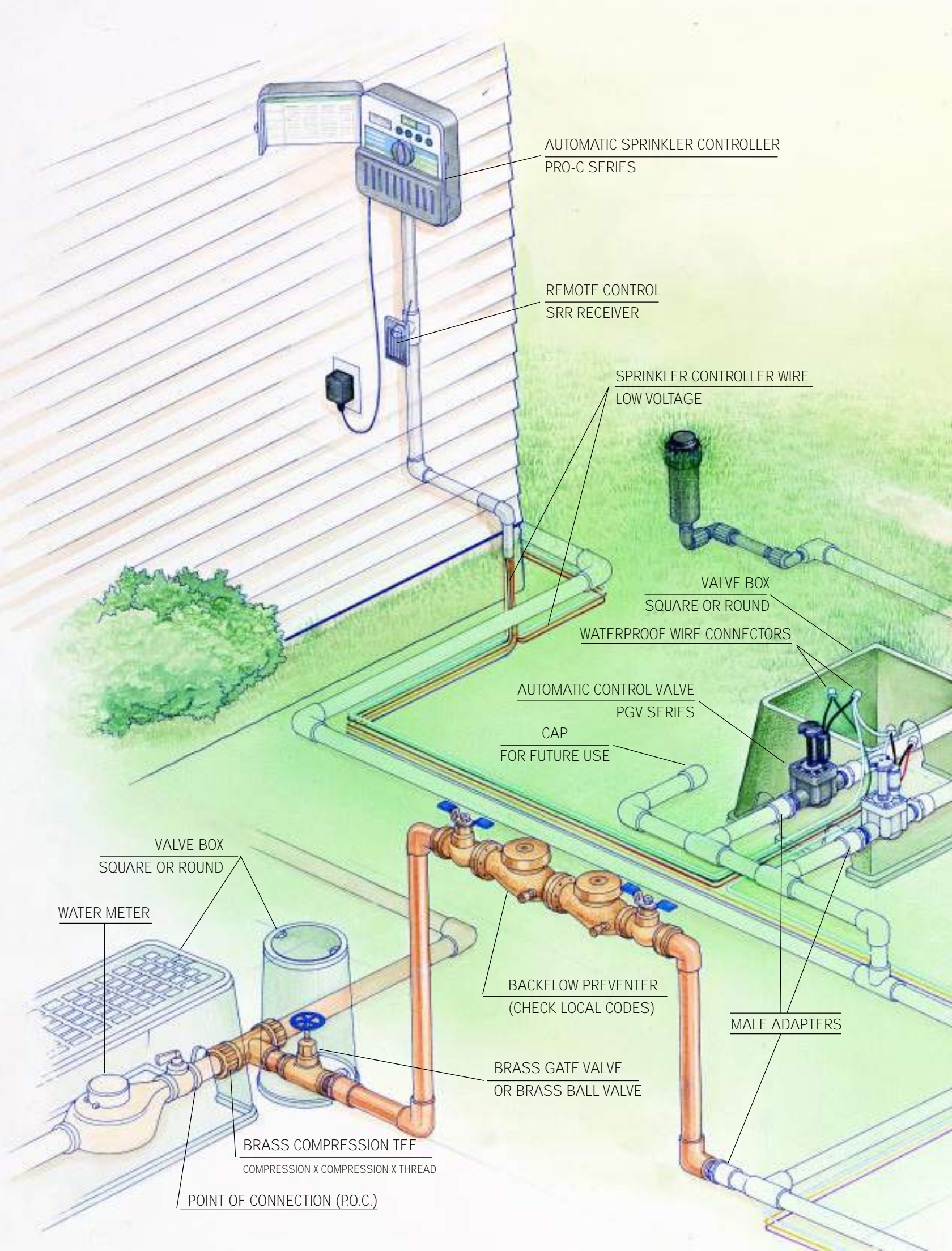

AUTOMATIC SPRINKLER CONTROLLER
PRO-C SERIES

REMOTE CONTROL
SRR RECEIVER

SPRINKLER CONTROLLER WIRE
LOW VOLTAGE

VALVE BOX
SQUARE OR ROUND

WATERPROOF WIRE CONNECTORS

AUTOMATIC CONTROL VALVE
PGV SERIES

CAP
FOR FUTURE USE

VALVE BOX
SQUARE OR ROUND

WATER METER

BACKFLOW PREVENTER
(CHECK LOCAL CODES)

BRASS GATE VALVE
OR BRASS BALL VALVE

MALE ADAPTERS

BRASS COMPRESSION TEE
COMPRESSION X COMPRESSION X THREAD

POINT OF CONNECTION (P.O.C.)

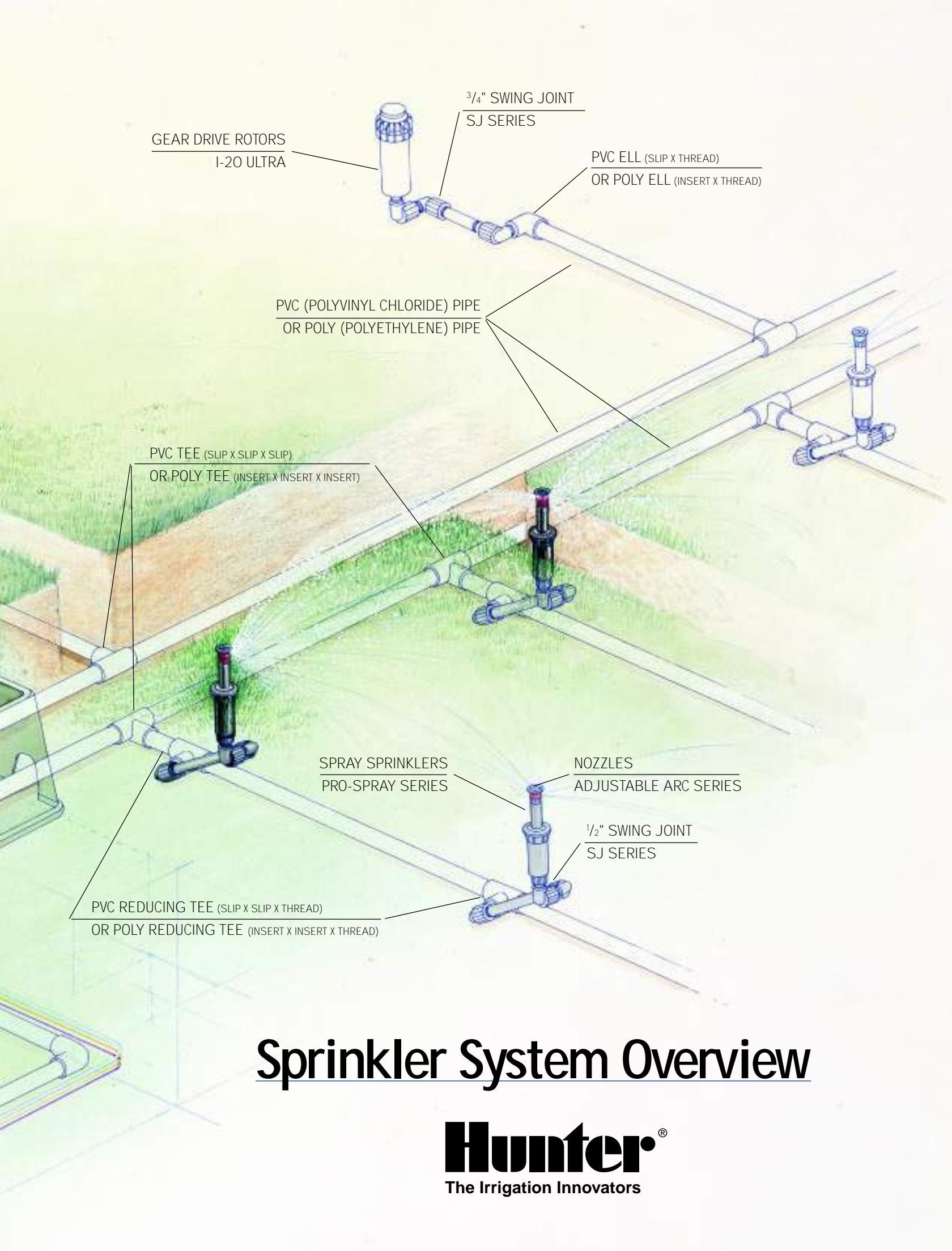

GEAR DRIVE ROTORS
I-20 ULTRA

3/4" SWING JOINT
SJ SERIES

PVC ELL (SLIP X THREAD)
OR POLY ELL (INSERT X THREAD)

PVC (POLYVINYL CHLORIDE) PIPE
OR POLY (POLYETHYLENE) PIPE

PVC TEE (SLIP X SLIP X SLIP)
OR POLY TEE (INSERT X INSERT X INSERT)

SPRAY SPRINKLERS
PRO-SPRAY SERIES

NOZZLES
ADJUSTABLE ARC SERIES

1/2" SWING JOINT
SJ SERIES

PVC REDUCING TEE (SLIP X SLIP X THREAD)
OR POLY REDUCING TEE (INSERT X INSERT X THREAD)

Sprinkler System Overview

Hunter[®]
The Irrigation Innovators

System Installation

H. System Installation

Making the Point of Connection

1. Refer to the Point Of Connection (P.O.C.) detail on the Sprinkler System Overview (pages 8 - 9).
2. Turn off the water supply to the residence.
3. Dig a hole to expose the supply line.
4. Cut a 1" piece out of the supply line, slip the compression tee onto the pipe, and tighten the compression nuts.
5. Install the brass nipple and gate valve.
6. Install the valve box for easy access to gate valve.
7. Turn the water back on to the residence.

Installing the Main Line

1. Using marking spray paint, indicate the pipe lines from the P.O.C. to the valve manifold locations.
2. On existing lawns, lay down a plastic tarp alongside the marked trench about 2' away from where the pipe will be placed.
3. Remove the sod by cutting a strip about 12" wide and 1 1/2" to 2" deep using a flat shovel. Roll up the sod and place the sod and dirt on the plastic tarp.
4. Trenching: Check local codes. If there are no established local codes for sprinkler main line depth in your area, trench 10" to 12" deep. Trenching can be done by hand or with a trencher. Trenchers are available at most equipment rental yards.
5. Installing Pipe Under a Walkway or Driveway:
Hammering Method: Cap off both ends of a galvanized pipe and hammer through (See illustration).
Jetting Method: Using a pipe-to-hose threaded adapter, connect one end of the pipe to a garden hose and attach a small stream hose nozzle to the other end. Turn the water on and jet under the concrete.
6. Install the backflow preventer according to local codes.
7. Installing Pipe: Lay out pipe and fittings near the trenches according to how they will be installed. Be careful not to get dirt or debris in the pipe.
8. Beginning with the P.O.C. (or backflow preventer if applicable), measure, cut and install the pipe, working your way to the last manifold or stub-out. (See Sprinkler System Overview on pages 8 - 9.)
9. Backfilling the main line is discussed on page 12 .



Before trenching, use small flags and marking spray paint to lay out the irrigation system.



First lay down tarps and remove sod, then dig trenches 10" to 12" deep for the main line. Trench 6" to 8" for lateral lines.



Connect pipe under a walk or driveway by capping off the ends of galvanized pipe and "hammering" through.

System Installation

Installing the Valve Manifolds

1. Refer to the valve manifold detail on the Sprinkler System Overview.
2. Maintain at least a 6" clearance between valves for future maintenance.
3. Provide a 3" long or longer capped stub-out for future additions.
4. Install the valve manifolds onto the main line.
5. Installing the valve boxes is discussed on page 12 .

Installing the Lateral Lines

If you can only devote a day or two at a time to installing this system, and the installation is in an area that is currently landscaped, lay out all zones and install one zone at a time using the following steps:

1. **Lay Out System:** Using the plot plan and small sprinkler flags, mark the location of the sprinklers and their zone valve. Make adjustments as necessary for complete head-to-head coverage. If it appears that you will need to revise the plan (add a head), recheck the GPM numbers to make sure you are within the system's design capacity. (See page 5.) Recheck the Pipe Sizing Chart to make sure the change will not affect the pipe sizes designated. (See page 6.)
2. **Using marking spray paint,** mark the locations for the lateral lines.
3. **Trenching:** Check local codes. If there are no established codes for sprinkler lateral line depth in your area, dig the trenches 6" to 8" deep. If you are installing poly pipe, you may want to use a pipe puller, which may be available at your local rental yard.
4. **Installing Pipe:** Lay out pipe and fittings at the side of the trenches according to how they will be installed. Be careful not to get dirt and debris inside the pipe.
5. **Backfilling the lateral line** is discussed on page 12.

TIP

Use pipe cutters to cut your PVC sprinkler pipe. Any plastic burrs left behind when using a hacksaw can clog up your sprinkler heads. When using pipe cutters, turn the PVC pipe 1/8 to 1/4 turn while applying pressure with the cutters. This reduces the risk of breaking the PVC.



Assembling PVC: 1. Place solvent on inside of fitting and outside of pipe.



PVC: 2. Slip pipe into fitting and wipe off excess solvent.



Assembling Poly Pipe: 1. Place clamp over pipe, then insert barb fitting.



Poly Pipe: 2. Tighten clamp around pipe and fitting.



Lay out the pipes and sprinklers near the trenches where they will be installed.

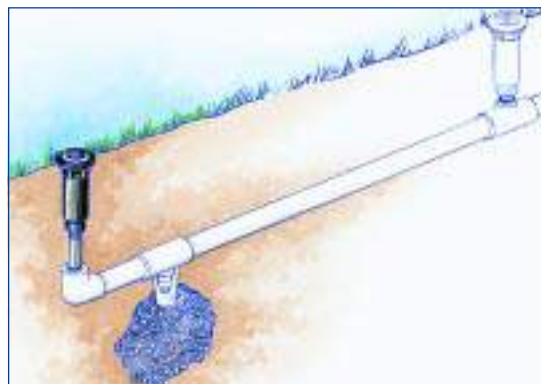

Automatic Drain Valve Installation for Freezing Climates: Locate the drain valves at the low points in each zone.

System Installation

Installing the Controller

1. Decide where you would like to locate the controller. Most residential controllers should be installed indoors, i.e. the garage. Follow the installation instructions that come with the controller. You will need a 115V electrical outlet to plug in the low voltage transformer.
2. Use color-coded irrigation wire to connect the valves to the controller. The total number of wires you need is one for each of the valves, plus one common wire. If you are wiring a 5-zone system, purchase a combination of wires with at least 6 total wires long enough to reach from your controller to the farthest valve.
3. **Installing Wire:** Lay the wire in the trench from the controller to the valve manifolds. It is best to protect the wire from future digging by installing it directly beneath the pipe where possible. Leave an expansion loop of wire at each change of direction. The loop will ensure that the wires will not be installed too tightly and will reduce the possibility of stretching.
4. Connect the wires to the valves with waterproof connectors. You will need one wire for each valve, plus one common wire which will be connected to one of the wires on all of the valves.

Installing Heads

1. Install all the heads but the last head on a run. Leave the last one(s) off for proper flushing.
2. **Flushing System:** Turn on the zone manually at the valve. Allow the water to flush out any dirt which may have entered the system. Flush the system even if you are sure nothing got in during installation. When you are certain that the water is clean, turn the zone valve off and install the remaining heads.
3. **Checking for Proper Coverage:** Turn the zone on at the controller. By activating the controller, you are making sure that the wire and wire connectors are operating properly. Adjust the sprinklers and check for coverage.

Backfilling

1. Do not directly bury the valves. Install a valve box for easy access to valves. Wait until you are backfilling the trench to set the valve box.
2. Make sure there are no rocks directly next to the pipe. Backfill one-third to one-half of the depth of the trench at a time, compacting the dirt as you go. Make sure to allow for the extra dirt on the sod when setting the sprinkler heads and valve boxes.



Use color-coded irrigation wire to connect the valves to the controller. You will need one wire for each valve, plus one common wire.



SRR Remote Control Kit
The Hunter SRR Remote Control Kit saves time during installation and routine system maintenance. The receiver (left) plugs into the Controller Connection Kit and the transmitter (above) activates the sprinklers within a 450' range. The user can manually run any zone without resetting the controller.

TIP

When deciding how many sprinkler wires you need, add at least two extra wires for each valve manifold for future expansion. It is much easier to install them now than later after the landscape has grown back in.

Materials List

Using the plot plan and the check lists below, do a take-off to determine your Materials List. If you are unsure what a part is called, check the Sprinkler System Overview. Use colored pencils and as you count or measure each component, mark the plan and write the item down here on this Materials List. Make sure to list everything on your plan.

- Point of Connection:** Detail and list the materials needed by size. Check the backflow prevention requirements for your area and record the materials needed.
- Pipe:** Measure and list pipe by size. Be sure to add a little additional pipe for waste. Count and list the number of main line and lateral line fittings by size and type.



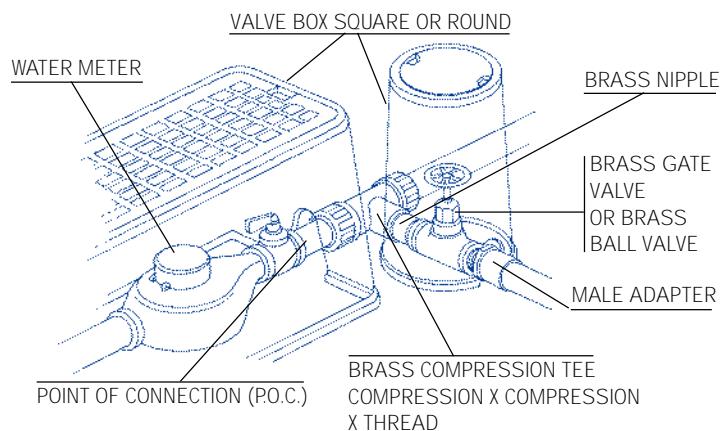

1. POINT OF CONNECTION		
List all the items needed for the system's point of connection.		
	Exterior	Interior
Brass Compression Tee (compression x compression x thread)		
Brass Gate Valve or Brass Ball Valve		
Valve Box		

1. Exterior Point of Connection - Non Freezing

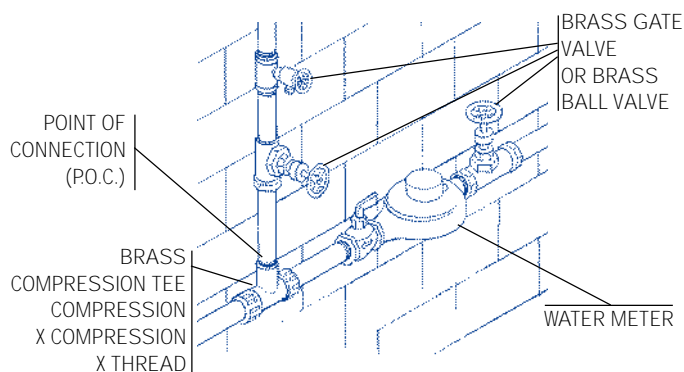

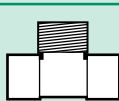
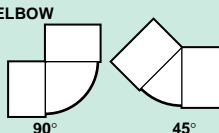
1. Interior Point of Connection - Freezing Climates

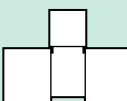

2. PIPE AND FITTINGS (Calculate the length of pipe and number of fittings required.)					
PVC (slip x slip x slip)		3/4"	1"	1 1/4"	Poly (insert x insert x insert)
PVC PIPE FEET REQUIRED	MAIN				MAIN
	LATERAL				LATERAL
TEE 	S x S x S				i x i x i
	S x S x 1/2" T				i x i x 1/2" T
	S x S x 3/4" T				i x i x 3/4" T
ELBOW 	90° S x S				90° i x i
	90° S x 3/4" T				90° i x 3/4" T
	90° S x 1" T				90° i x 1" T
	45° S x S				45° i x i
REDUCER BUSHING 	1" S x 3/4" S				1" i x 3/4" i
	1 1/4" S x 1" S				1 1/4" i x 1" i
REDUCING TEE 	S x S x S				i x i x i
MALE ADAPTERS 	S x T				i x T
COUPLING 	S x S				i x i

S = Slip Fitting

T = Threaded Fitting

i = Insert Fitting

Materials List

3. Control Valves: Count the number of valves by size. Using the valve detail, list the materials needed.

4. Controller: The number of valves will determine the size of the controller required. You will need one controller station for each valve. Measure the wire run from the controller to the farthest valve. *Note: Use color-coded, multi-conductor low voltage wire. You will need one wire for each valve, plus one common wire which will be connected to all of the valves.*

Example: On your plot plan, if you need 8" of wire and your scale is 1" = 10', then you will need 80' of wire (8 x 10' = 80'). Do not forget to add a little extra wire at the valve so that it makes it easier to work on the wire connectors, and enough wire to go up the wall to hook up the controller.

3. AUTOMATIC CONTROL VALVES

List all the items needed to build the valve manifolds.

	Size	Quantity
Hunter SRV or PGV Valve	1"	
Valve Box		
Male Adapters		
Waterproof Wire Connectors		

4. CONTROLLER

Hunter SRC or Pro-C Controller	_____ Stations
SRR Remote Control Kit	
18 Gauge, Direct Burial Wire with Number of Strands _____	_____ Feet

TIP

Never drop PVC pipe. If it is dropped and hits a rock or concrete the pipe could shatter and send tiny sharp pieces flying. Even if the pipe does not break, it could get a hairline crack and later burst under normal water pressure. This can also happen if the pipe is allowed to slap together while being carried.

3. Valves

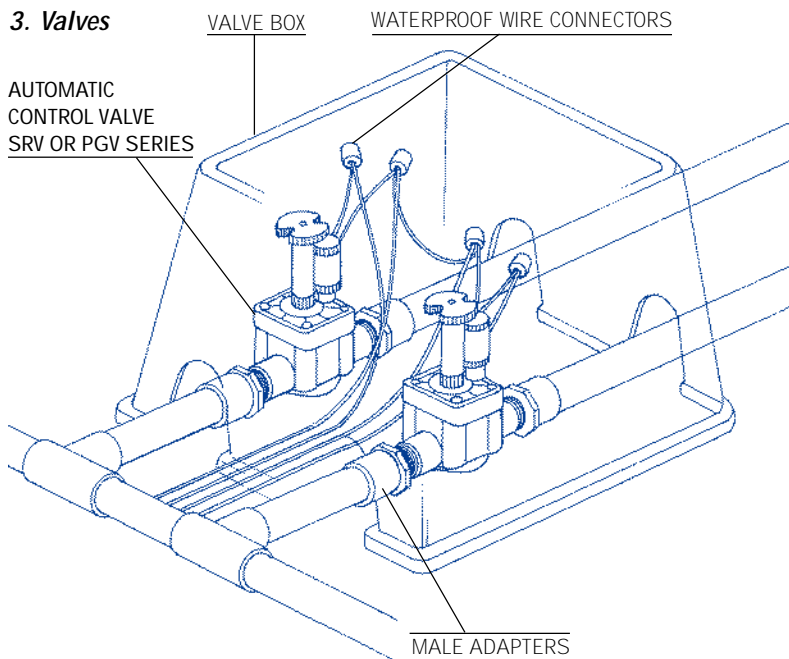

4. Controller

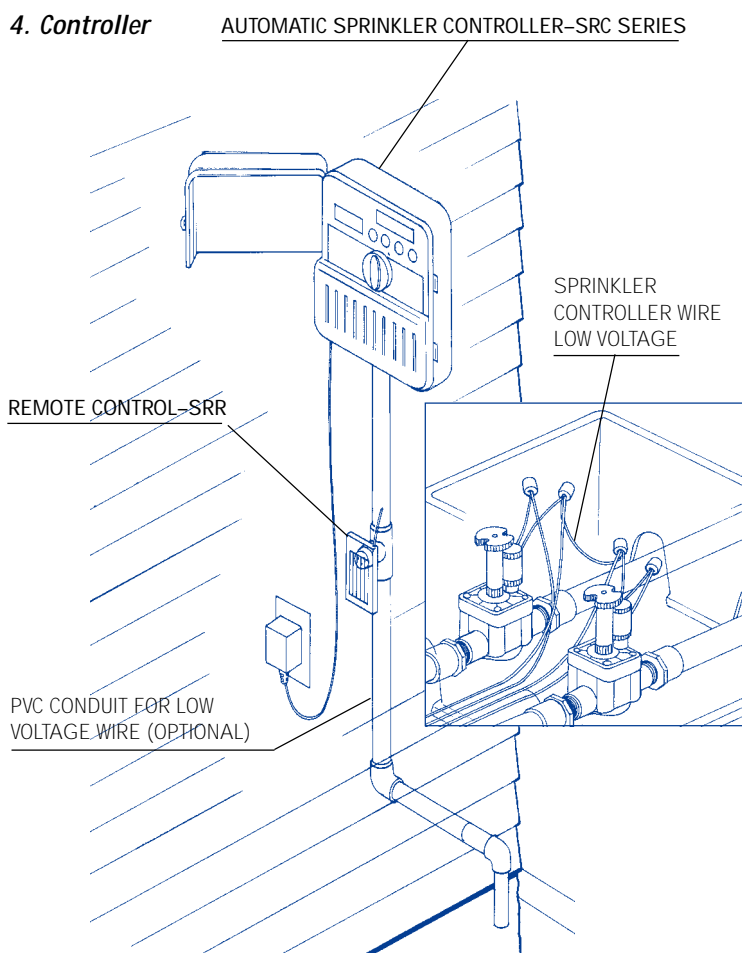

Materials List

- Sprinklers:** Count the number of sprinkler heads needed by type and record the totals in the chart.
- Swing Joints:** Count the sprinkler heads and determine the number of pre-assembled Hunter swing joints needed, or
- Calculate the number of fittings needed by size.

5. SPRINKLERS		
Count all of the sprinklers on your plan and list here:		
GEAR DRIVE ROTORS - POP-UP AND SHRUB		
POP-UP, LAWN		Quantity
PGM 1/2" inlet		
PGP 3/4" inlet		
I-20 Ultra 3/4" Inlet		
SHRUB - RISER MOUNTED OR HIGH POP-UP		
PGM 1/2" inlet		
PGP 3/4" inlet		
I-20 Ultra 3/4" inlet		

SPRAY SPRINKLERS WITH ADJUSTABLE ARC NOZZLES		
POP-UP, LAWN		Quantity
Pro-Spray 1/2" inlet		
PS 1/2" inlet		
SHRUB - RISER MOUNTED OR HIGH POP-UP		
Pro-Spray 1/2" inlet		
PS 1/2" inlet		

6. HUNTER SWING JOINTS, PRE-ASSEMBLED		
SJ SERIES		Quantity
SJ-506	1/2" x 6"	
SJ-512	1/2" x 12"	
SJ-7512	1/2" x 3/4" x 12"	
SJ-712	3/4" x 12"	

7. SWING JOINT ASSEMBLIES			
Transfer the number of sprinklers required from Step 5 to the area provided below, then determine the quantity of parts needed:			
1/2" Inlet Sprinkler			Total
1/2" Marlex Street Ell	x 3	=	
1/2" x 8" sch 80 nipple for Pop-up	x 1	=	
1/2" x 14" (or ___") nipple for Shrub	x 1	=	
3/4" Inlet Sprinkler			Total
3/4" Marlex Street Ell	x 3	=	
3/4" x 8" sch 80 nipple for Pop-up	x 1	=	
3/4" x 14" (or ___") nipple for Shrub	x 1	=	

5. Sprinklers

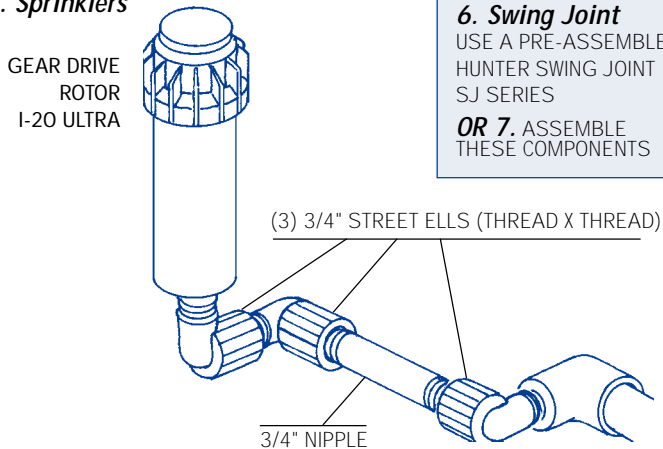

6. Swing Joint
USE A PRE-ASSEMBLED HUNTER SWING JOINT SJ SERIES
OR 7. ASSEMBLE THESE COMPONENTS

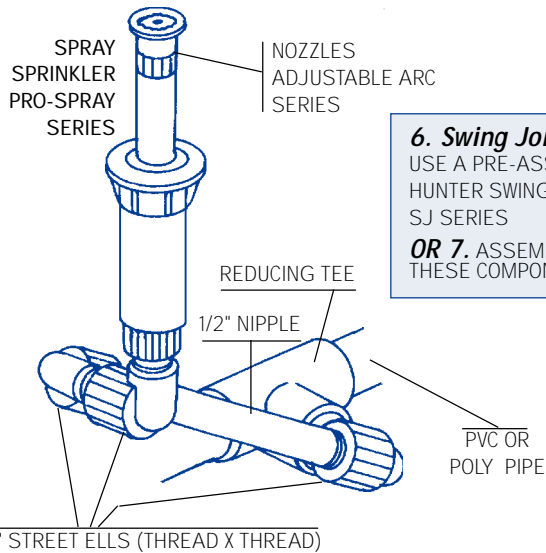

6. Swing Joint
USE A PRE-ASSEMBLED HUNTER SWING JOINT SJ SERIES
OR 7. ASSEMBLE THESE COMPONENTS

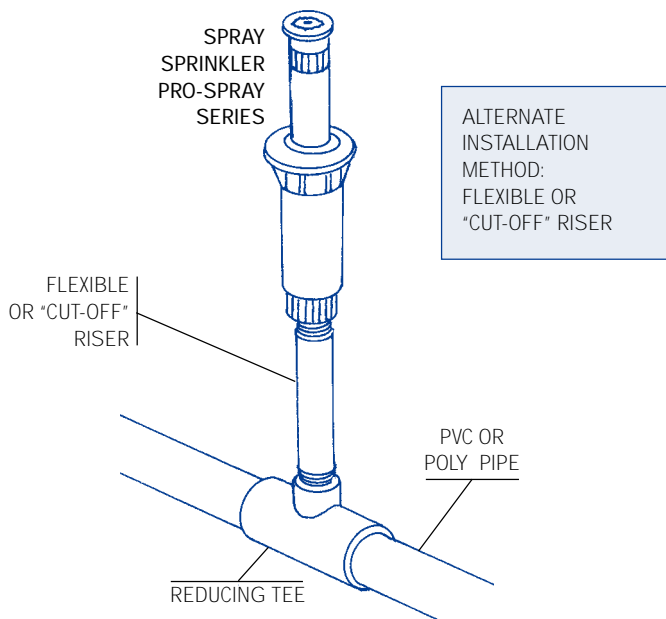

Glossary of Terms

ARC - Describes how far around in a circular pattern a sprinkler will rotate or spray. A sprinkler with a 90° arc would spray a quarter circle.

BACKFLOW PREVENTER - A device installed between the P.O.C. and the sprinklers that is designed to prevent the backflow of contaminated water into the drinking water. Different areas of the country require different types of backflow preventers. The user should check with their Hunter dealer or local permitting agency for the type of backflow device approved for their area.

CHECK VALVE - A small device allowing water to flow in one direction only. A check valve has a spring which will hold the valve closed, and will not allow the water to flow out of the sprinkler until a pre-set pressure is achieved in the system. This spring will hold back water in a pipe that has as much as 7' to 10' change in elevation and is an excellent solution for slope applications.

CONTROLLER - Also known as a timer, the part of an automatic sprinkler system that determines when a valve will turn on and how long it will operate. The timer sends a low voltage signal to the valve, which will then open for a predetermined amount of time allowing water to flow to the sprinklers. What size timer to purchase is determined by how many zones are in the sprinkler system.

FRICTION LOSS - Water flowing through the meter, valves, pipe, and fittings has considerable drag or friction. When the velocity of water increases, the friction loss increases. The friction reduces the available static pressure.

GPM - Gallons Per Minute - The available GPM must be known before a sprinkler design can be completed. Sprinkler heads have different GPM requirements. The total GPM of all the sprinkler heads on one zone should not exceed the available GPM.

HEAD-TO-HEAD - This phrase describes the correct placement of spray heads and stream rotors. One sprinkler must be placed so that it will spray another sprinkler (or 50% of the adjusted diameter). This provides for complete coverage and prevents dry spots.

LATERAL (Lateral Line) - Non-pressure pipe running from the valve to the sprinklers.

LOW HEAD DRAINAGE - Water left in the pipe after a valve is turned off that is gently flowing out of a low elevation sprinkler head.

MAIN (MAIN LINE) - Pressurized pipe running from the P.O.C. to the zone control valves.

MANIFOLD - A group of valves.

P.O.C. - POINT OF CONNECTION - The sprinkler main line tie-in point.

POLY PIPE - Polyethylene is black, flexible pipe popular in areas that are susceptible to long freezes in the winter. An insert fitting with a hose clamp or a compression fitting is used with poly pipe.

PRECIPITATION RATE - Expressed in inches per hour, precipitation rate is the rate at which water is being applied. Matched precipitation means all of the sprinklers in the area are placing about the same amount of water on a given area. Different types of sprinklers should not be installed in the same zone. Large area sprinklers and small area sprinklers may use the same GPM, but because the size of the areas they cover is not the same, the inches per hour of water applied is very different.

PRESSURE - Measured with a pressure gauge and expressed in pounds per square inch (PSI). Static pressure is the PSI measured when no water is flowing through a closed system. Dynamic pressure is the PSI measured when the system is open, or water is flowing through.

PROGRAM - A program is information the user enters into the timer's memory that determines when the system will water. A program for an automatic sprinkler timer contains three pieces of information: what days to water, what time to start watering all zones, and how long each zone will water.

PVC PIPE - The most common type of pipe used in areas with warmer climates. Generally white in color, PVC (polyvinyl chloride) pipe is more rigid than the black poly pipe, and requires the use of PVC solvents (glue). The pipe manufacturers also recommend the use of primer just prior to the application of the solvent. Some examples and descriptions of PVC pipe are as follows:

SCH 40 - A thick-walled pipe most commonly used for main lines.

CL 200 - Piping with medium-thick walls and strength.

CL 160 - A thin-walled pipe that should only be used for lateral lines.

RADIUS - How far out from the sprinkler the water sprays. A nozzle with a 17' radius means that the water will spray out as far as 17'.

ROTORS - Gear-driven sprinklers that shoot out a solid stream of water and rotate slowly in a circular pattern, streaming out water to areas as small as 17' and as large as 75' or more. Rotors fit into the "large area sprinklers" category.

SPRAY HEADS - A sprinkler that emits a fan-type spray of small droplets of water. These heads have a radius of 17' and shorter. Spray heads fit into the category of "small area sprinklers."

STATION - A term used when discussing controllers. Sprinklers in a watering zone are connected by pipe to a valve, which is wired to a station on the controller. A 6-station controller (also called a timer) can control from one to six valves.

TIMER - See "Controller"

TRENCH - Lateral line trenches should be at least 6" to 8" deep. When digging in the yard most people will dig without concern to about a 4" depth. At 6" they begin to dig more carefully, as they know there are utilities buried in their yard. Installing the lateral pipes at 6" to 8" helps to avoid broken pipes due to weeding or the planting of annual color. The main line is usually installed before the lateral lines and should be deeper, allowing the lateral lines to be installed at the stated depth. As an added note, install the low-voltage wires in the same trench below the main line pipe to help protect the wires.

VALVE - In a sprinkler system, there are many types of valves, but really only two families of valves—sprinkler valves and shut-off valves. Within those two families are a variety of valves. When discussing a sprinkler system, the term "valve" usually refers to an automatic control valve.

SHUT-OFF VALVES

GATE VALVES have a wheel type handle. Several turns of the handle are required to turn off a gate valve. Gate valves are most commonly used on main line pipes with high water pressure or high water flow. Because several turns are required, they are easier to turn off and the potential for water hammer is reduced. Gate valves have a brass to brass seat and are not recommended for frequent use.

BALL VALVES have a single arm or lever that requires a quarter turn to turn on or off. This single action is convenient, but caution should be used and the valve should not be turned on or off too quickly while water is flowing, as damage could result. Ball valves have resilient seats and are better for frequent use applications.

SPRINKLER ZONE CONTROL VALVES

MANUAL CONTROL VALVES are not as common as they once were.

The manually-controlled sprinkler system eliminates having to move a hose-end sprinkler around from area to area, but the user does not have the convenience of the automatic system.

AUTOMATIC CONTROL VALVES are used in conjunction with automatic timers and are a convenient, economical way of delivering water to lawns, plants and gardens. With an automatic system, the user does not have to worry about wasting water when they forget to turn the system off. Instead, just the right amount of water is delivered to each zone automatically.

VOLUME - Expressed in GPM (gallons per minute), volume is used to describe either the amount of water available or the amount of water used.

WATER HAMMER - The surging of pressure which occurs when a control valve is suddenly closed. In extreme conditions, this surging will cause the pipes to vibrate or create a pounding noise. Water hammer is most commonly caused by fast-closing valves or pipes that have been sized too small causing high velocity water flow.

WIRE - In an automatic sprinkler system, low voltage direct burial wire is used to connect the automatic control valves to the controller. The most frequently used wire for the home sprinkler system is multi-strand. Color-coded, multi-strand sprinkler wire has several coated wires together in one protective jacket. It is a good idea to install extra wires for future expansion of the system.

ZONE - A zone is an area to be watered by one sprinkler valve.

Watering Guidelines

Application Rates

Watering application rates will vary with different types of plants, soils and climates. New lawn must be kept moist, and newly-transplanted shrubs must be watered every day or two. Established plants will need deeper, less frequent watering. The following guidelines will get you started.

Watering Guidelines

1. Do not operate more than one valve at a time.
2. Water early in the morning when it is least windy and pressure is the greatest. Early morning watering will also reduce water evaporation. Watering in the early evening is not recommended. A lawn is more likely to get diseases when wet for a long duration, especially overnight during the summer. Watering on a hot summer day may also burn the plants.
3. In most areas, lawns require 1 1/2" to 2" of water per week in the hottest months. Hot and arid areas may require more.
4. Manually activate your system every week or so to make sure everything is operating correctly. Check and clean sprinklers to ensure proper functioning.

Freezing Areas

In freezing climates, turn off the controller, close the main sprinkler shut-off valve, drain all the water from the system, and blow any remaining water out of the system before the first freeze. If you are unfamiliar with the correct procedure for blowing out a sprinkler system, contact your local Hunter dealer for assistance or a referral.













WATERING GUIDELINES	
Cool, non-arid climates – Apply 1" of water per week. Hot, arid climates – Apply 2" of water per week.	
Clay soils, fine particles, absorbs water slowly	Program the controller with shorter run times; increase the number of start time cycles per day; decrease the number of water days per week.
Loam soils, medium-sized particles, average absorption rate	Program the controller with longer run times and fewer start time cycles per week.
Sandy soils, larger particles, absorbs water quite rapidly	Program the controller with shorter run times; increase the number of start time cycles per day; increase the number of water days per week.

SPRINKLER RUN TIME SCHEDULE – OR 7 DAYS				
Water To Apply Each Week	Spray Sprinklers	PGM Rotors	PGP Rotors	I-20 Ultra Rotors
1"	40 min.	130 min.	150 min.	150 min.
2"	80 min.	260 min.	300 min.	300 min.



An automatic controller stores information on what days to water, what time to start watering and how long each zone will run.

Hunter Sprinkler Performance Charts

HUNTER SPRAYS				
	PSI	Radius in Feet	GPM	
10-FOOT SPRAY				
	25	10	0.39	
	30	11	0.49	
	35	11	0.51	
	25	10	0.78	
	30	11	0.97	
	35	11	1.02	
	25	10	1.56	
	30	11	1.95	
	35	11	2.04	
12-FOOT SPRAY				
	25	12	0.56	
	30	13	0.71	
	35	14	0.76	
	25	12	1.12	
	30	13	1.42	
	35	14	1.52	
	25	12	2.24	
	30	13	2.85	
	35	14	3.05	
15-FOOT SPRAY				
	25	15	0.88	
	30	16	0.93	
	35	16	1.03	
	25	15	1.75	
	30	16	1.86	
	35	16	2.06	
	25	15	3.50	
	30	16	3.71	
	35	16	4.12	
17-FOOT SPRAY				
	25	17	1.13	
	30	18	1.20	
	35	18	1.25	
	25	17	2.25	
	30	18	2.41	
	35	18	2.50	
	25	17	4.50	
	30	18	4.82	
	35	18	5.01	

PGM MID-RANGE ROTOR				
Nozzle	PSI	Radius in Feet	GPM	
.50	30	14	0.42	
	40	15	0.50	
	50	15	0.58	
.75	30	17	0.64	
	40	18	0.75	
	50	18	0.85	
1.0	30	20	0.85	
	40	21	1.00	
	50	21	1.10	
1.5	30	23	1.30	
	40	24	1.50	
	50	24	1.70	
2.0	30	25	1.70	
	40	27	2.00	
	50	27	2.30	
3.0	30	28	2.50	
	40	30	3.00	
	50	30	3.40	

PGP ROTOR				
Nozzle	PSI	Radius in Feet	GPM	
3	30	30	0.9	
	40	31	1.0	
	50	31	1.2	
4	30	32	1.2	
	40	33	1.4	
	50	34	1.6	
5	30	34	1.6	
	40	36	1.8	
	50	38	2.0	
6	30	36	2.0	
	40	38	2.4	
	50	40	2.7	
7	30	36	2.6	
	40	40	3.0	
	50	42	3.4	
8	30	37	3.2	
	40	40	3.7	
	50	43	4.2	
9	30	38	4.2	
	40	43	4.9	
	50	46	5.5	
10	40	45	6.0	
	50	48	6.8	
	60	49	7.6	

I-20 ULTRA ROTOR				
Nozzle	PSI	Radius in Feet	GPM	
1.0	30	30	0.9	
	40	31	1.0	
	50	31	1.2	
1.5	30	32	1.2	
	40	33	1.4	
	50	34	1.6	
2.0	30	34	1.6	
	40	36	1.8	
	50	38	2.0	
3.0	30	36	2.0	
	40	38	2.4	
	50	40	2.7	
3.5	30	36	2.6	
	40	40	3.0	
	50	42	3.4	
4.0	30	37	3.2	
	40	40	3.7	
	50	43	4.2	
6.0	30	38	4.2	
	40	43	4.9	
	50	46	5.5	
8.0	40	45	6.0	
	50	48	6.8	
	60	49	7.6	

TIPS

Sprinkler Radius: The radius can be reduced up to 25% with a sprinkler adjustment tool.

PSI: If the PSI at the sprinkler is higher than the ratings recommended in the charts, you may need a pressure regulator.

Low Angle Nozzles: These nozzles project a lower spray pattern and are ideal for slopes or where low tree branches or wind are a problem.

PGP LOW ANGLE				
Nozzle	PSI	Radius in Feet	GPM	
5	30	25	1.6	
	40	27	1.9	
	50	28	2.1	
6	30	27	2.1	
	40	30	2.5	
	50	33	2.8	
7	30	29	2.8	
	40	32	3.1	
	50	35	3.5	
8	30	31	3.4	
	40	34	3.9	
	50	37	4.4	

I-20 ULTRA LOW ANGLE				
Nozzle	PSI	Radius in Feet	GPM	
2.0LA	30	25	1.6	
	40	27	1.9	
	50	28	2.1	
2.5LA	30	27	2.1	
	40	30	2.5	
	50	33	2.8	
3.5LA	30	29	2.8	
	40	32	3.1	
	50	35	3.5	
4.5LA	30	31	3.4	
	40	34	3.9	
	50	37	4.4	

NOTE: Not all nozzle charts included here. Ask your dealer for a complete Hunter catalog for more information.

Choosing Nozzles

When designing an irrigation system, it is important to ensure that the precipitation (rate at which water is applied) is even over each zone of coverage. "Matched precipitation" is accomplished by selecting the appropriate nozzles, or zoning together sprinklers with the same precipitation rate. The two criteria to consider are a sprinkler's flow rate and arc of coverage. The illustration (right) depicts three different sprinkler heads with matched precipitation rates. In each case, one gallon per minute (GPM) is applied to each quarter circle and precipitation is therefore matched.

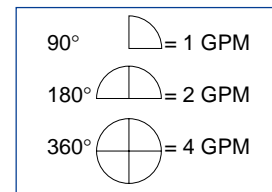

Example: If you have decided to use the I-20 Ultra and have quarter, half and full circle heads on the same zone, you could use the 1.0, 2.0 and 4.0 nozzles or the 2.0, 4.0 and 8.0 nozzles, depending on your available GPM.

