

# EC

## Residential Irrigation Controller

2, 4 or 6 Station Indoor or Outdoor Versions  
Owner's Manual and Programming Instructions

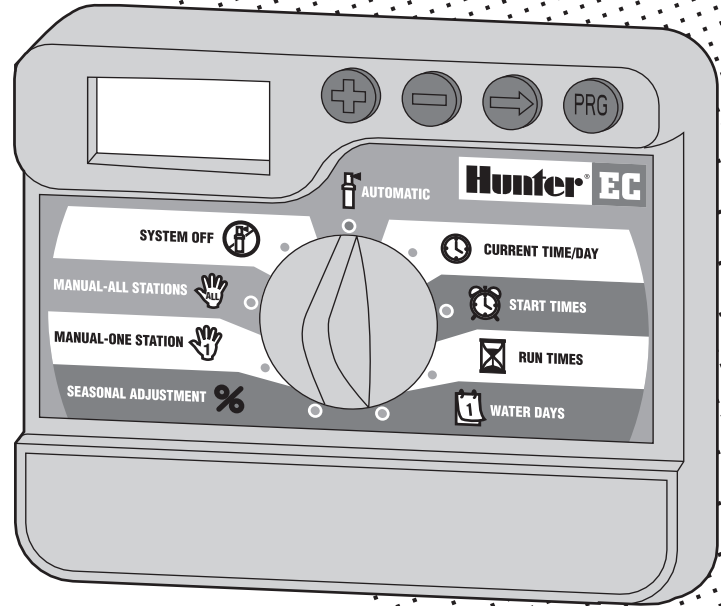

# Hunter®



# **TABLE OF CONTENTS .....**

## **INTRODUCTION AND INSTALLATION**

Introduction .....	1
EC Components (Indoor Model) .....	2-3
EC Components (Outdoor Model) .....	4-5
Mounting the Indoor Controller to Wall .....	6
Mounting the Outdoor Controller to Wall .....	7
Connecting Valves and Transformer .....	8
Connecting the Battery .....	9
Connecting a Master Valve .....	9
Connecting a Pump Start Relay .....	10
Connecting a Weather Sensor .....	11
Power Failures .....	11

## **CONTROLLER PROGRAMMING AND OPERATION**

Sprinkler System Fundamentals .....	12
Programming Fundamentals .....	13
Creating a Watering Schedule .....	14
How to Fill Out the Watering Schedule Form .....	14
Watering Schedule Form (Example) .....	15
Watering Schedule Form .....	16
Programming the Controller .....	17
Setting the Date and Time .....	17
Setting Watering Start Times .....	18
Eliminating a Program Start Time .....	18

# **TABLE OF CONTENTS (continued).....**

## Programming the Controller (Continued)

Setting Station Run Times (Length of Watering for Each Area) .....	19
Setting Days To Water .....	19
Selecting Specific Days of the Week to Water .....	19
Selecting Interval Watering .....	20
Automatic .....	20
System Off .....	20
Bypass Weather Sensor .....	20
Seasonal Adjustment .....	20
Manually Run a Single Station .....	21
Manually Run All Stations .....	21
One Touch Manual Start and Advance .....	22

## **TROUBLESHOOTING AND SPECIFICATIONS**

Troubleshooting Guide .....	23-24
Frequently Asked Questions .....	25
Specifications .....	26-27
Quick Programming Guide .....	29-30
FCC Notice .....	Back Cover

# **INTRODUCTION** .....

Finally, there's an affordable irrigation system controller for your home.

Hunter Industries is pleased to present the EC – an Irrigation Controller for residential and commercial applications. Designed with the needs of the customer in mind, the EC offers simplified dial programming and an impressive range of features typically found in controllers costing twice as much.

While it's affordable, the EC is without a doubt a professional grade product. The compact, lightweight design provides a neat and professional appearance. And, the EC is filled with the essential features that landscapes demand (like a seasonal adjustment and primary power surge protection.), but without some of the unnecessary frills that often lead to customer confusion.

The EC is so easy to use that after reading this User Guide thoroughly, you will need it very little after installation. We have also included an abbreviated instruction sheet on pages 29 and 30 for quick reference.

You can be sure the EC is a controller that does the job efficiently and economically.

# EC COMPONENTS (INDOOR MODELS).....

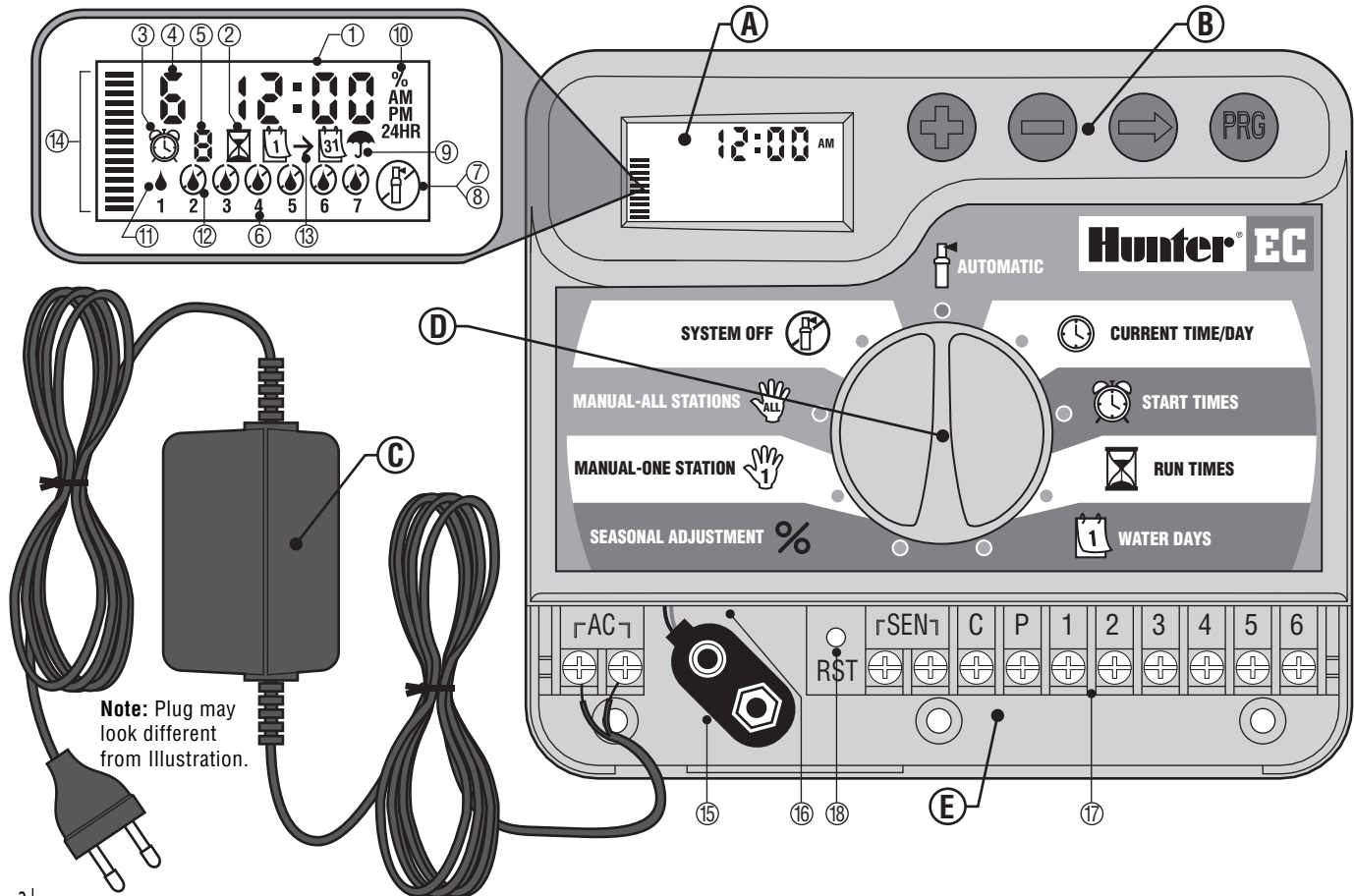

**Note:** Plug may look different from illustration.

This section will give you a brief overview of some of the components on the indoor version of the EC. Each item will be discussed in further detail later, however this section can be helpful in getting acquainted with the different options available.

## A – LCD Display

1. **Main Display** – Indicates all programmed information.
2. **Run Times** – Icon indicates when Run Times are being set.
3. **Start Times** – Icon indicates when Start Times are being set.
4. **Station Number** – Indicates currently selected station number.
5. **Program Designator** – Identifies program in use A, B, or C.
6. **Day of the Week** – Day of the week is indicated by number 1 to 7.
7. **Flashing Sprinkler** – Indicates that watering is occurring.
8. **Crossed Sprinkler** – Indicates that watering is suspended.
9. **Umbrella** – Indicates Rain Sensor is suspending irrigation.
10. **Percent** – Indicates that Seasonal Adjustment is being made.
11. **Rain Drop** – Indicates watering will occur on that selected day.
12. **Crossed Rain Drop** – Indicates watering will NOT occur on selected day.
13. **Calendar** – Indicates interval watering schedule is being programmed.
14. **Bars** – Indicate seasonal adjust percentage.

## B – Control Buttons









- ⊕ Button – Increases the selected flashing display.
- ⊖ Button – Decreases the selected flashing display.
- ➡ Button – Advances the selected flashing display to the next item.
- Ⓜ Button – Selects program A, B or C for different watering zone requirements.

## C – Transformer

A plug in transformer is provided to supply AC power to the controller.

A key feature of the EC is its clear, easy-to-use dial design that makes programming a snap. All essential keypad functions are clearly marked to eliminate the confusion that's a characteristic of so many other controllers.

## D – Control Dial

-  **Automatic** – Normal dial position for all controller automatic and manual operation.
-  **Current Time/Day** – Allows current day and clock time to be set.
-  **Start Times** – Allows 1 to 4 start times to be set in each program.
-  **Run Times** – Allows user to set each valve station run time from 1 minute to 4 hours.
-  **Water Days** – Allows user to select individual days to water or a selected number of days between waterings (interval).
-  **Seasonal Adjustment** – Allows user to make run time changes according to the seasons without reprogramming.
-  **Manual-One Station** – Allows user to activate a one time watering of a single valve station.
-  **Manual-All Stations** – Allows user to activate a one time watering of all valve stations or a few selected stations.
-  **System Off** – Allows user to discontinue all programs and stop all watering. Also allows the user to set the controller to a timed off until dial is returned to the Automatic position.

## E – Wiring Compartment

15. **9-Volt Battery Connector** – The alkaline battery can be used to program the controller in the absence of AC power. Even without a 9-volt battery the EC will keep track of time for up to 1 month and retain the program indefinitely in the event of a power outage.
16. **Battery Compartment** – Compartment for the 9-volt battery.
17. **Terminal Strip Area** – Use to attach transformer and valve wires from their source to the controller.
18. **Reset Button** – Use to reset the controller.

# EC COMPONENTS (OUTDOOR MODELS) .....

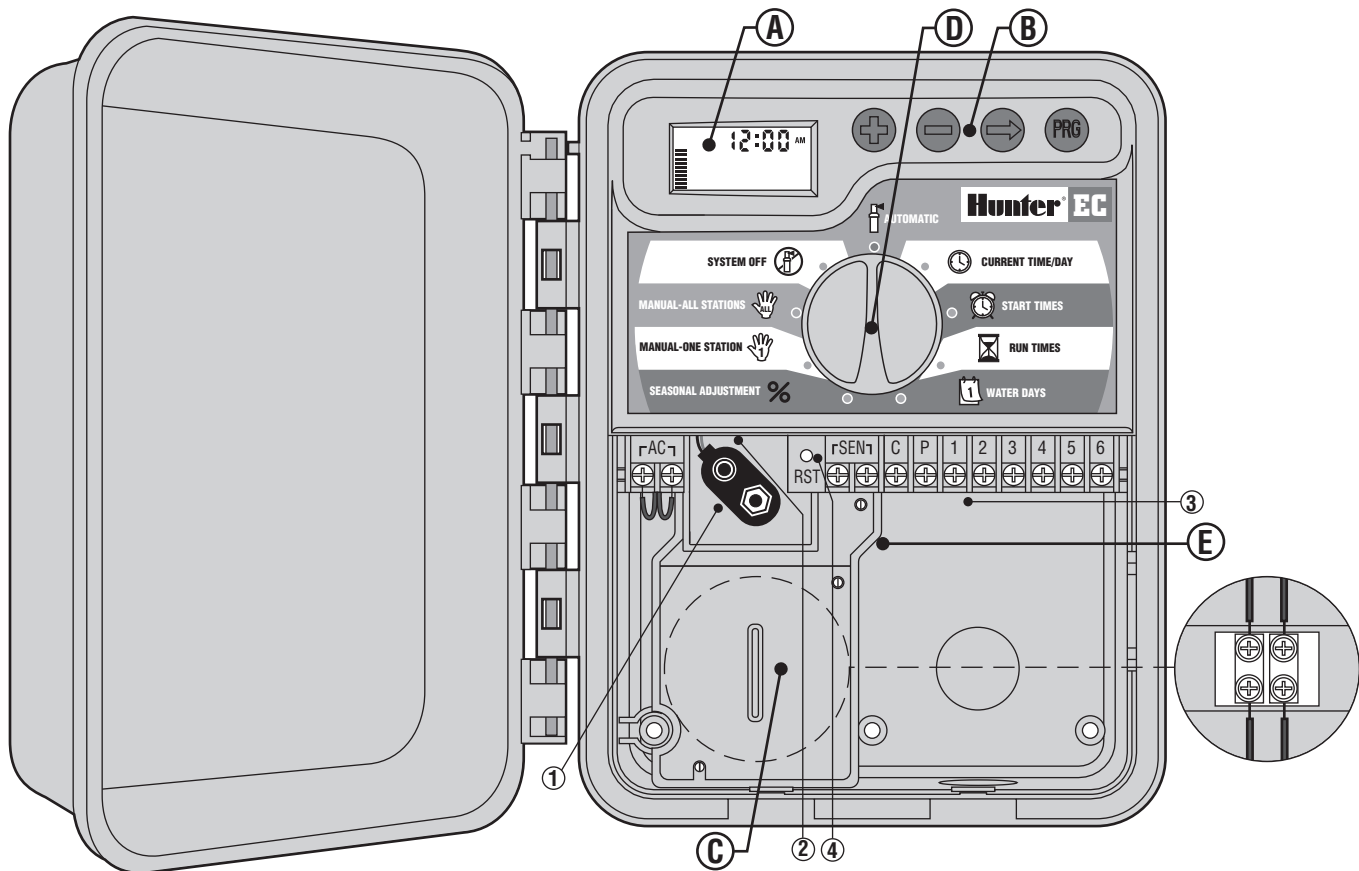



This section will give you a brief overview of some of the components on the outdoor version of the EC. Each item will be discussed in further detail later, however this section can be helpful in getting acquainted with the different options available.

### A – LCD Display (See page 2 for LCD Display Detail Illustration)

#### B – Control Buttons









- ⊕ Button – Increases the selected flashing display.
- ⊖ Button – Decreases the selected flashing display.
- ➡ Button – Advances the selected flashing display.
- Ⓜ Button – Selects program A, B or C for different watering zone requirements.

#### C – High Voltage Wiring Compartment

Route AC power cable and conduit through the 1/2" (13 mm) conduit opening on the the left side of the bottom of the cabinet and connect the wires to the AC terminal strip located inside the junction box door below the transformer. Always use a local authority approved conduit 1/2" (13 mm) male adapter when installing the AC wiring. Insert the adapter (male threads first) into the 1/2" (13 mm) hole at the bottom of the controller until it enters the wiring enclosure. Attach the nut to the adapter inside the enclosure. It is recommended that the power installation be performed by a licensed electrician.

A key feature of the EC is its clear, easy-to-use dial design that makes programming a snap. All essential keypad functions are clearly marked to eliminate the confusion that's a characteristic of so many other controllers.

#### D – Control Dial

-  **Automatic** – Normal dial position for all controller automatic and manual operations.
-  **Current Time/Day** – Allows current day and clock time to be set.
-  **Start Times** – Allows 1 to 4 start times to be set in each program.
-  **Run Times** – Allows user to set each valve station run time from 1 minute to 4 hours.
-  **Water Days** – Allows user to select individual days to water or a selected number of days between waterings (interval).
-  **Seasonal Adjustment** – Allows user to make run time changes according to the seasons without reprogramming.
-  **Manual-One Station** – Allows user to activate a one time watering of a single valve station.
-  **Manual-All Stations** – Allows user to activate a one time watering of all valve stations or a few selected stations.
-  **System Off** – Allows user to discontinue all programs and stop all watering. Also allows the user to set the controller to a timed off until dial is returned to the Automatic position.

#### E – Wiring Compartment

- 1. 9-Volt Battery Connector** – The alkaline battery can be used to program the controller in the absence of AC power. Even without a 9-volt battery the EC will keep track of time for up to 1 month and retain the program indefinitely in the event of a power outage.
- 2. Battery Compartment** – Compartment for the 9-volt battery.
- 3. Terminal Strip Area** – Use to attach valve wires from their source to the controller.
- 4. Reset Button** – Use to reset the controller.

# MOUNTING THE INDOOR CONTROLLER TO WALL .....



**NOTE:** The indoor EC is not water or weather resistant, and must be installed indoors or in a protected area.

1. Select a location as close as possible to a standard electrical outlet, one that is not controlled by a light switch. The location should be protected from moisture and direct sunlight.
2. Place the controller at eye level. Use the hole at the top of the controller as a reference and secure one 25 mm screw (A) into the wall. **Note: Install screw anchors if attaching to drywall or masonry wall.**
3. Align controller with the screw and slide the keyhole (B) on top of the controller over the screw.
4. Secure controller in place by installing screws in the holes (C) below the terminal strip area.



**Do not plug transformer into power source until the controller is mounted and all valves have been connected.**

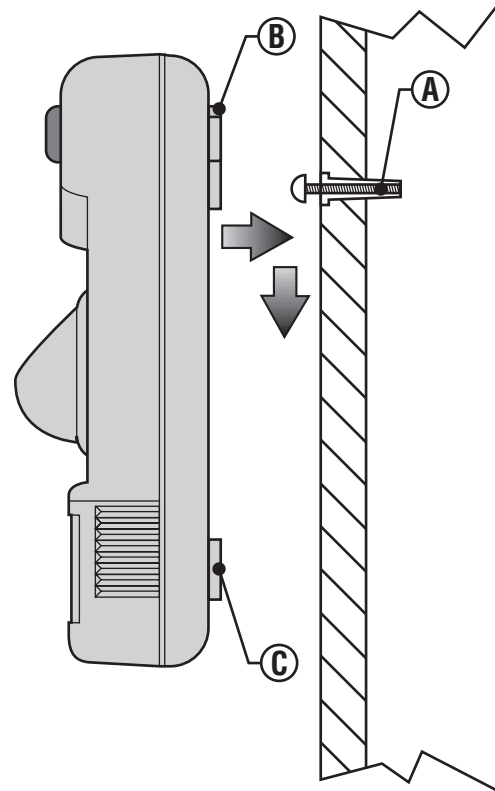

# MOUNTING THE OUTDOOR CONTROLLER TO WALL .....



**NOTE:** Outdoor model is water and weather resistant. Connecting the outdoor EC to the primary power should only be done by a licensed electrician following all local codes. Improper installation could result in shock or fire hazard.

1. Select a location that is conveniently close to a power supply.
2. Make sure to abide by all electrical and installation codes when attaching to an external wall.
3. Place the controller at eye level and align keyhole (A) on top of the controller and mark the spot as well as the three holes (B) on the bottom of the unit.
4. Drill a 6 mm hole at each mark.
5. Install screw anchors (C) into holes if attaching controller to drywall, masonry, or plaster walls.
6. Holding the controller cabinet, line up the holes in the cabinet with the wall anchors or pilot holes.
7. Drive a screw through each hole and secure snugly but do not over tighten.

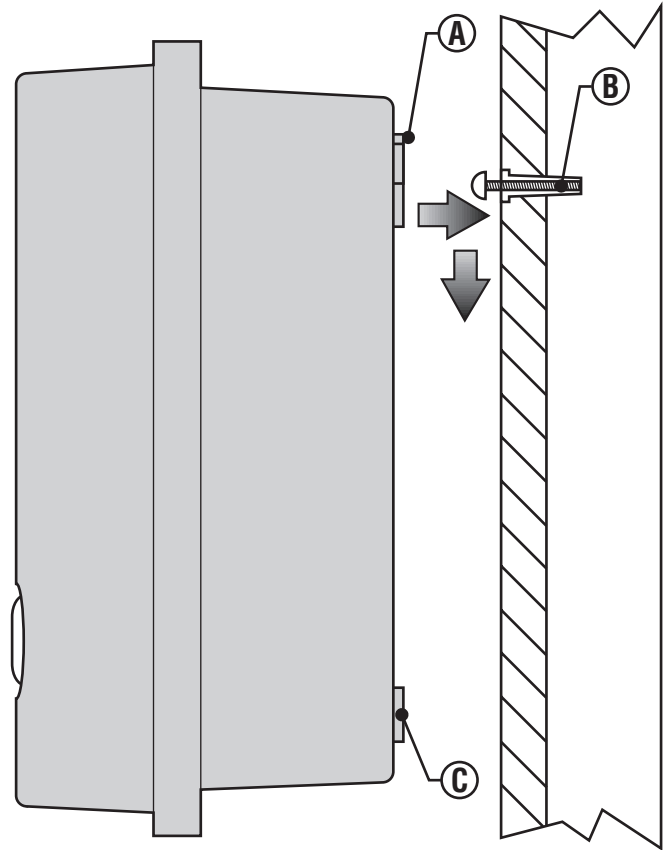

# CONNECTING VALVES AND TRANSFORMER .....

1. Route control wires between valve location and controller. Typically it is recommended that at least 1 mm diameter conductor cable be used. This type of cable is insulated for burial and is color-coded to help keep track of your connections.
2. At the valves, attach the common wire to either solenoid wire of the valve. This is most commonly a white colored wire. Attach a separate control wire to the remaining solenoid wire and make a note of the color corresponding to each valve and the watering station it controls.
3. Secure the wires with a waterproof wire connector to protect the connection.
4. Slide down wiring compartment door to access the terminal strip area shown in the diagram.
5. Route the valve wires into the cabinet. Strip 5 mm of insulation from ends of all wires.
6. Secure the white valve common wire to the screw on the terminal marked C. Connect the color-coded wires from the valves to their appropriate station numbers and tighten the screws.
7. For the indoor model, route transformer cable through the left side of the controller and connect the wires to the two screws marked AC.
8. Before closing the compartment door make sure wires hang in the slotted areas so that the door can snap shut without damaging wires.

9. For the outdoor model, transformer wires are already connected to the AC slots so all that is required is to connect primary power to the junction box from a power source.
10. Remove junction box cover and attach power wires to either screw slot. Be sure to use a code approved conduit and adapter for the primary wires.

 **Do not plug transformer into power source until the controller is mounted and all valves have been connected.**

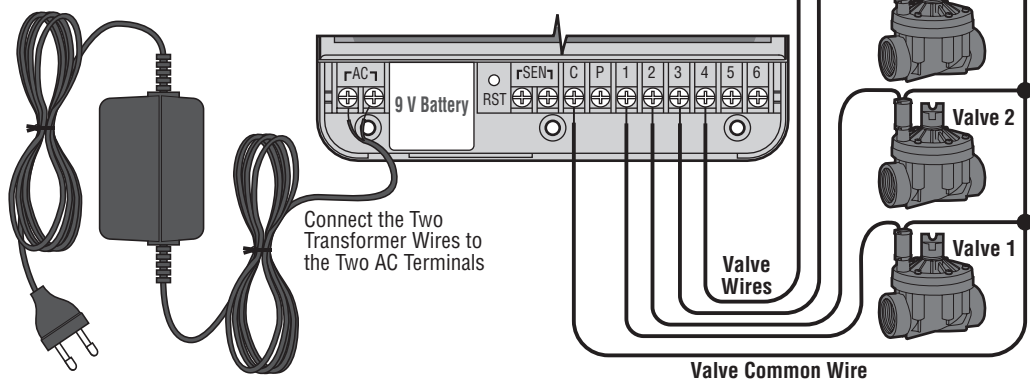

## CONNECTING THE BATTERY .....

Connect a 9-volt alkaline battery (not included) to the battery wire clip located in the lower left-hand side of the controller. The battery will allow you to program the controller without AC power. However, the battery will not be able to activate any of the station valves. AC power must resume before watering will continue.

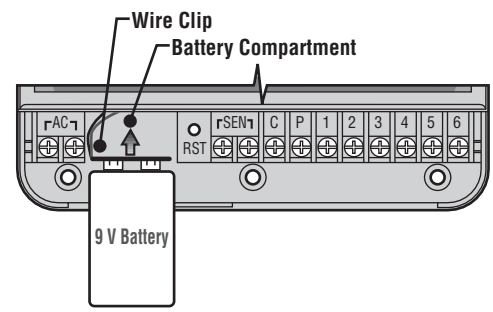

## CONNECTING A MASTER VALVE .....

**NOTE:** Complete this section only if you have a master valve installed. A master valve is a “normally closed” valve installed at the supply point of the main line that opens only when the controller initiates a watering program.

1. At the Master Valve, attach the common wire to either solenoid wire of the valve. Attach a separate control wire to the remaining solenoid wire and make a note of the color corresponding to the master valve.
2. Route these wires to the controller the same way as the station valves. The white common wire will still go to the screw slot marked C. The additional wire coming from the master valve will go in the screw slot marked P.

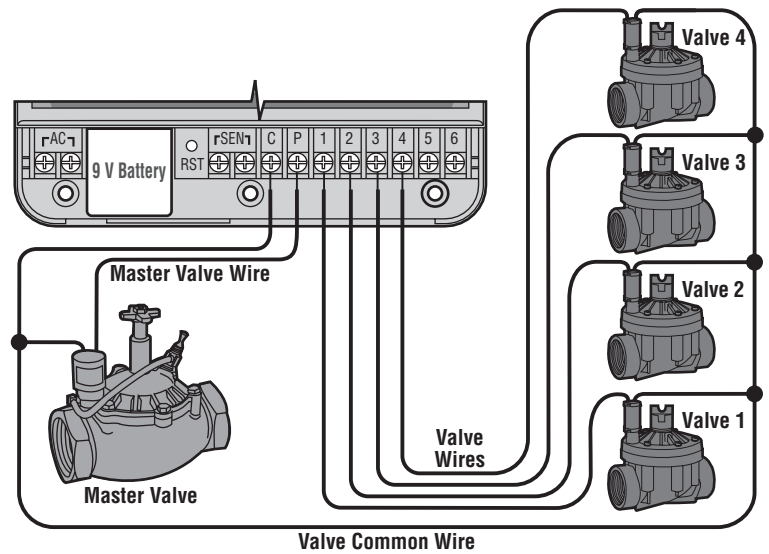

## CONNECTING A PUMP START RELAY .....



**NOTE:** Complete this section only if you have a pump start relay installed. A pump start relay is a device that uses a signal from the controller to actuate a separate electrical circuit to energize a pump to provide water to your system.

1. Route a wire pair from the pump relay into the controller housing.
2. Connect common wire to the screw slot C (Common) and the remaining wire from the pump relay to the P screw slot.

Relay holding current draw must not exceed .28 Amps. Do not connect controller directly to pump – damage to controller can result.

The controller should be mounted at least 4.5 m away from both the pump start relay and the pump. When a pump start relay comes on it sends out surges that may potentially cause damage to a controller that is mounted too close. When a pump is to be operated by the controller, a pump start relay must be used. Hunter offers a full range of pump start relays for most applications.

PSR Series  
Pump Start Relay



4.5 Meters Minimum (15')

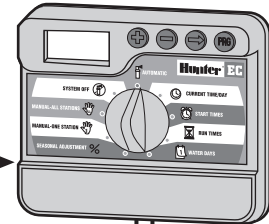

To Pump

## CONNECTING A WEATHER SENSOR .....

A Hunter Mini-Clik® rain sensor or other type of micro-switch weather sensor can be connected to the EC. The purpose of this sensor is to stop watering when weather conditions dictate.

1. Remove the jumper that is attached across the SEN terminals of the controller.
2. Route the two wires from the rain sensor up through the same opening used for valve wiring.
3. Connect one wire to the SEN terminal and one to the other SEN terminal.



**NOTE:** If the rain sensor is interrupting irrigation you can bypass it by using any of the following: **MANUAL-ONE STATION, MANUAL-ALL STATIONS, or ONE TOUCH START AND ADVANCE.** See section “Rain Sensor Bypass” for more information.

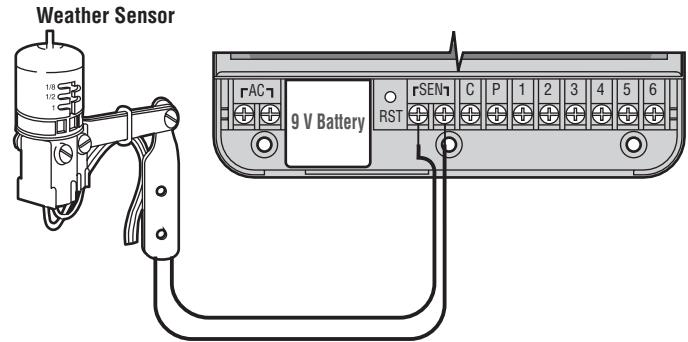

## POWER FAILURES .....

Due to the possibility of power failures, the controller has non-volatile memory. Programmed information will never be lost. The controller will keep the correct time for up to 1 month without power. Normal watering will resume when AC power is restored.

# SPRINKLER SYSTEM FUNDAMENTALS.....

There are three main components that are involved with all automatic sprinkler systems that are made today. They are the **controller**, **control valves**, and the **sprinklers**.

The **controller** is what makes the whole system operate efficiently. It is technically the brain of the entire system, instructing the valves when to supply water to the sprinklers and for how long to do so. The sprinklers, in turn, will direct the water towards the surrounding plants and lawn.

The valve controls a group of sprinklers called a watering **station**. These stations are laid out in a fashion according to the type of plant life that

exists there, the locations of the plants, and the maximum amount of water that can be pumped to the location. Each valve is connected via wire to the terminal strip area inside of the controller. Here the wire is connected to a number that corresponds to the valve's station number.

The controller will operate the valves in order, only one at a time. When a valve has completed its watering; it will switch to the next station that has been programmed. This process is called the watering cycle. The information pertaining to the watering times of the individual stations and how often watering occurs is called a **program**.

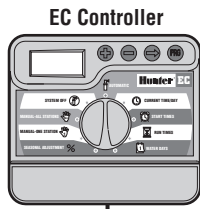

- Valve 1** – Activates Station 1 – Rotors water front yard lawn
- Valve 2** – Activates Station 2 – Sprays water side lawn and bubblers water flowers
- Valve 3** – Activates Station 3 – Rotors water back yard lawn
- Valve 4** – Activates Station 4 – Bubblers water garden
- Valve 5** – Activates Station 5 – Sprays water side lawn and bubblers water flowers
- Valve 6** – Activates Station 6 – Sprays water front corner lawn

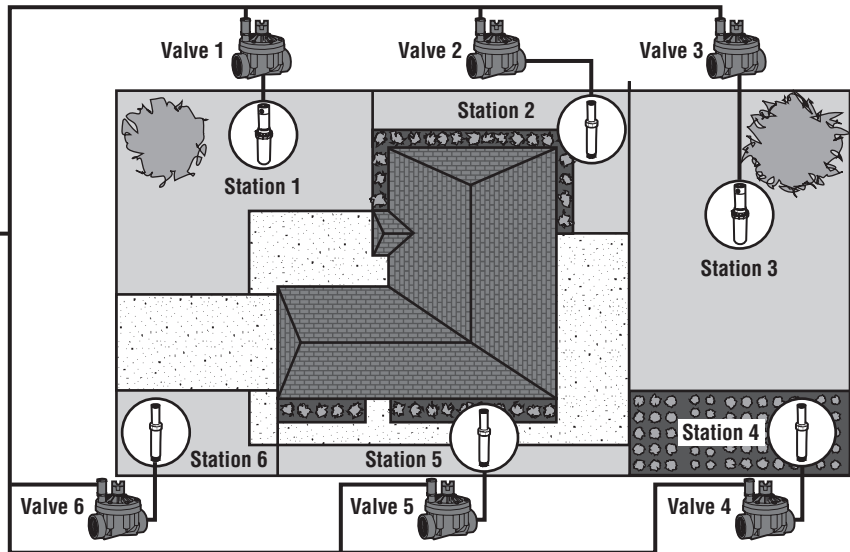



# PROGRAMMING FUNDAMENTALS .....

For the controller and its selected program to operate automatically, there are three components that must exist: 1. When to water – or **Watering Start Times**. 2. How long to water – or **Station Run Times**. 3. What day of the week to water – or **Days to Water**.

We have included an example that will better illustrate the operation of a program. Let's say you have a program start time set for 6:00 AM. Stations 1 and 2 are going to have a run time of 15 minutes and station 3 is set for 20 minutes. Please note that stations 4 and 5 have not been included in this program, we will water them on separate programs.

Going back to our previous example, at 6:00 AM the controller will activate the watering cycle. The sprinklers on station 1 will run for 15 minutes and then automatically shut off. The controller will automatically activate station 2 sprinklers. These sprinklers will also run for 15 minutes and then shut off. Then, watering on station 3 will begin automatically. The sprinklers will turn on for 20 minutes and shut off automatically. Since no times were programmed for stations 4 and 5, the controller skips them. This will conclude the program and end the water cycle at 6:50 AM.

As shown in the above example, **only one program start time** was required to run the three different stations. The controller automatically moves to the next station without the need for additional start times.

We realize that many consumers will have variations in their plant watering needs, so at Hunter we equipped the EC with three different programs A, B, and C. These programs are completely independent of each other and give you the ability to have three coexisting timers in one controller.

For example, using more than one program would enable you to water on odd days for lawn stations 1, 2, and 3 on program A, station 4 to soak the flowers every day on program B, and station 5 and station 6 to water on even days on program C. However, it is not absolutely

necessary to use this feature. Many homes and businesses can have all zones adequately watered on one program with the other programs turned off for future use.

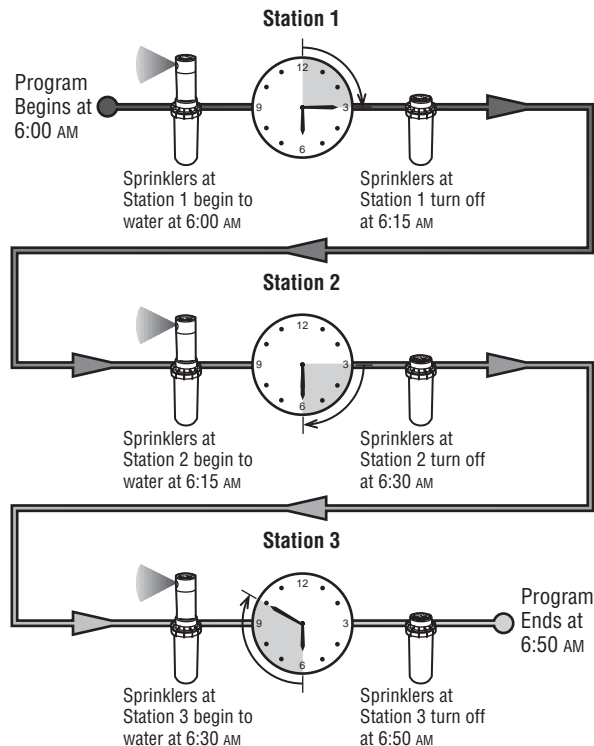

## CREATING A WATERING SCHEDULE.....

For most consumers, it is much easier to plan your specific watering schedule onto paper before actually programming the information into the controller. It's also handy to have a written record of your programming information for easy reference.

There are some guidelines that should be followed when determining when and how long to water. These factors are the soil type, the part of the landscape being watered, weather conditions, and the types of sprinklers being used. Since there are so many different variables that can determine your individual watering schedule, it is impossible to give an exact schedule to follow. However, we have included some guidelines to help you get started.



**It is usually good to water one or two hours before sunrise. Water pressure will be at optimum levels during the early morning and the water can soak into the roots of the plants while evaporation is minimal. For most plants, watering during midday or in the evening may cause plant damage or possibly mildew.**



**Keep an eye out for evidence of under- or over-watering. Over-watering is most commonly indicated by pools of water that take a long time to soak in or evaporate, while under-watered landscapes will show signs of discoloring and dryness. Make programming changes immediately when evidence is present.**

## HOW TO FILL OUT THE WATERING SCHEDULE FORM.....

Be sure to use a pencil when filling out this form. By using the included example and the information below, you should have all the information you need to construct your personal water schedule.

**Station Number and Location** – Identify the station number, location and the type of plant that is being watered.

**Watering Day** – Identify whether you want to use a calendar day or an interval day schedule. For a calendar day schedule circle the day of the week in which watering is desired. For an interval day schedule, simply set the corresponding number of days.

**Program Start Times** – Indicate the time of day that the program will begin. Each program can have 1 to 4 start times. However, one start time can run an entire program.

**Station Run Time** – Indicate the run time (1 minute to 4 hours) for each station. Write “OFF” for any station that you do not want to operate in the program.

Keep this schedule in a safe place for quick reference later, rather than scrolling through program information on the controller.

# WATERING SCHEDULE FORM (EXAMPLE) .....

HUNTER EC		PROGRAM A							PROGRAM B							PROGRAM C							
DAY OF THE WEEK		①	②	③	④	⑤	⑥	⑦	1	②	3	④	5	⑥	7	1	2	3	4	5	6	7	
INTERVAL (Choose 1 to 31 days)																2							
PROGRAM START TIMES		1	6:00 AM							5:00 AM							7:00 AM						
		2	Off							Off							Off						
		3	Off							Off							Off						
		4	Off							Off							Off						
STATION	LOCATION	STATION RUN TIME							STATION RUN TIME							STATION RUN TIME							
1	Front Lawn	15							Off							Off							
2	Flowers	15							Off							Off							
3	Back Lawn	20							Off							Off							
4	Garden	Off							15							Off							
5	Side Lawn	Off							Off							20							
6	Front Corner	Off							Off							60							
NOTES:																							

# WATERING SCHEDULE FORM .....

HUNTER EC		PROGRAM A							PROGRAM B							PROGRAM C							
DAY OF THE WEEK		1	2	3	4	5	6	7	1	2	3	4	5	6	7	1	2	3	4	5	6	7	
INTERVAL (Choose 1 to 31 days)																							
PROGRAM START TIMES		1																					
		2																					
		3																					
		4																					
STATION	LOCATION	STATION RUN TIME							STATION RUN TIME							STATION RUN TIME							
1																							
2																							
3																							
4																							
5																							
6																							
NOTES:																							

# PROGRAMMING THE CONTROLLER

The EC Controller is easy to program. The easy to understand dial design allows you to step through the process of programming and activate manual watering with a twist of the wrist.

The EC display shows time and day when the controller is idle. The display changes when the dial is rotated to indicate the specific programming information to enter. When programming, the flashing portion of the display can be changed by pressing the **+** or **-** buttons. To change something that is not flashing, press the **→** button until the desired field is flashing.

Three programs A, B and C each with the ability to have four daily start times, permit plants with different watering requirements to be separated on different day schedules. Multiple start times permit morning, afternoon, and evening watering, perfect for the establishment of new lawns and thirsty annual flowers. Simply designate the days of the week you want to water. The EC makes it easy.



**NOTE: A basic programming rule is that whatever symbol or character is flashing will be the item programmed. For instance, if the hour is flashing when setting the time, the hour can be changed or programmed. For illustration purposes, flashing characters are in GRAY type.**

## Setting the Date and Time

1. Turn the dial to the **CURRENT TIME/DAY** position.
2. Hours will be flashing. Press the **+** or **-** button to change the hour shown on the display. Press the **→** to proceed to setting the minutes.
3. Minutes will be flashing. Use the **+** or **-** button to change the minutes shown on the display. Press the **→** to proceed to select AM, PM, or 24 hour time.
4. The time will be displayed, and an arrow will be flashing on AM. Press the **+** and **-** buttons to select AM, PM, or 24 hour. Press the **→** to proceed to setting the day of the week.
5. The number one will be flashing indicating the first day of the week. Press the **+** and **-** buttons to select the day of the week (1 through 7) corresponding to the day.

The time and day have now been set. You can turn the dial to **AUTOMATIC** to display the current time.

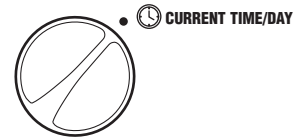

# PROGRAMMING THE CONTROLLER (continued) .....

## Setting Watering Start Times

1. Turn the dial to the **START TIMES** position.
2. The factory preset is set on program A. If necessary, you can select program B or C by pressing the **PRG** button.
3. Use the **+** or **-** button to change the start time. (The start times advance in 15 minute increments). Hold either button down for 1 second to change times rapidly.
4. Press the **→** button to select the next start time, or press **PRG** for the next program.

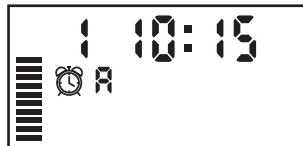

## Eliminating a Program Start Time

With the dial set to the **SET WATERING START TIMES** position, push the **+** or **-** button until you reach 12:00 AM (Midnight). From here push the **-** button once to reach the OFF position.

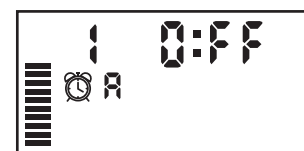

**NOTE:** If a program has all four-start times turned off, then that program is off. (All other program details are retained.) Because there are no start times, there will be no watering with that program. This is a convenient way to stop watering on one program only without turning the dial to the OFF position.



**NOTE:** One start time will activate all stations sequentially in that program. This eliminates the need to enter each station's start time. Multiple start times in a program can be used for separate morning, afternoon, or evening watering cycles.

## Setting Station Run Times (Length of Watering for Each Area)

1. Turn the dial to the **RUN TIMES** position.
2. The display will show the last program selected (A, B or C) the station number selected, run time icon, and the run time for that station will be flashing. You can switch to another program by pressing the **PRG** button.
3. Use the **+** or **-** button to change the station run time on the display.
4. Press the **➡** button to advance to the next station.
5. Repeat steps 3 and 4 for each station.
6. You can set station run times anywhere from 0 to 4 hours.
7. You can move between programs while staying on the same station. However, it is recommended that one program is completed before going on to the next program.



## Setting Days To Water

1. Turn the dial to the **WATER DAYS** position.
2. The display will show the last program selected (A, B or C). You can switch to another program by pressing the **PRG** button.
3. The controller will display the seven days of the week with a **▲** icon or a **⌚** icon above the numbered day. The **▲** icon would represent an "On" water day, while a **⌚** icon would represent an "Off" watering day.



## Selecting Specific Days of the Week to Water

1. With the **▲** cursor on a specific day (the cursor always starts with 1), press the **+** button to activate a particular day of the week to water. Press the **-** button to cancel watering for that day. After pressing a button the cursor automatically advances to the next day.
2. Repeat step 1 until all desired days have been selected. The selected days will show with a **▲** to indicate their status as ON. The last **▲** is the last day of watering for that program.

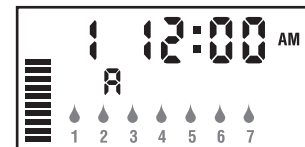





**NOTE: Jumping between programs can be confusing and may result in program entry errors.**

# PROGRAMMING THE CONTROLLER (continued) .....

## Selecting Interval Watering

With this option you can select interval watering from 1 to 31 days.

1. With the  cursor on day 7, press the  button until the two calendars and a flashing 1 appear in the display. Interval watering schedule appears on the display.
2. Press the  or  button to select the number of days between watering days (1 to 31). This is called the interval.

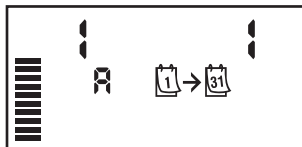

The controller will water the selected program at the next Start Time and will then water at the interval programmed.

Example: You program the controller at 8:00 AM for the following:

Program A  
Start Time 10:00 AM  
Interval = 5 days

The controller will run on today at 10:00 AM and water program A. Then, the controller will wait 5 days and water again at 10:00 AM and so on.

Had you programmed the controller at 11:00 AM rather than at 8:00 AM, the controller would have watered tomorrow at 10:00 AM and then watered every 5 days after that at 10:00 AM.

## Automatic

After programming is complete, turn the dial to **AUTOMATIC** to enable automatic execution of all selected programs and start times. Watering will not occur unless dial is in the **AUTOMATIC** position.

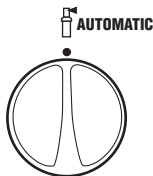

## System Off

Valves currently watering will be shut off after the dial is turned to the **SYSTEM OFF** position for two seconds. All active programs are discontinued and watering is stopped. To return controller to normal automatic operation, simply return dial to **AUTOMATIC** position.

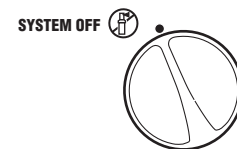

**NOTE:** Due to variances in pressure and flow, valve may take up to one minute to fully close.

## Bypass Weather Sensor

If there is a weather sensor installed that is interrupting irrigation, you can bypass it by using the manual watering options described below. The dial positions **MANUAL-ONE STATION** and position **MANUAL-ALL STATIONS** as well as the One Touch Start and Advance process will successfully bypass the rain sensor.

## Seasonal Adjustment

Seasonal Adjust is used to make global run time changes without re-programming the entire controller. This feature is perfect for making small changes that are necessary as the weather changes without reprogramming the entire controller. For instance, hotter times of the year may require a bit more water. Seasonal adjust can be increased so that the stations will run longer than the programmed time. Conversely, as Fall approaches, the seasonal adjust can be reduced to allow for short watering durations.





To use the seasonal adjustment feature:

1. Turn the dial to the **SEASONAL ADJUSTMENT** position.
2. The display will now show a flashing number followed by a %, as well as the bar graph which always remains on the display. Press the **+** or **-** buttons to adjust the percentage of the seasonal adjustment. Each bar on the graph represents 10%. This feature can adjust the controller from 10% to 150% of the original program.

To view the new adjusted run times, simply turn the rotary dial to the **SET STATION RUN TIMES** position, the displayed run time will be updated accordingly as the seasonal adjustment is made.



**NOTE: The controller should always be initially programmed in the 100% position.**

### Manually Run a Single Station

1. Turn dial to the **MANUAL-ONE STATION** position. 
2. Station run time will flash in the display. Use the **➡** button to move to the desired station. You may use the **+** or **-** button to select the amount of time for a station to water.
3. Turn the dial clockwise to the RUN position to run the station (only the designated station will water, then the controller will return to automatic mode with no change in the previously set program). Also see **One Touch Manual Start and Advance** on page 22.



### Manually Run All Stations

1. Turn dial to **MANUAL-ALL STATIONS**. 
2. Select program A, B, or C by pressing the **▶** button.
3. Press the **➡** button until desired starting station is displayed.
4. Station run time will flash in the display. Use the **+** or **-** button to select the amount of run time for the station to water if different from the run time displayed.
5. Use the **➡** button to move to the next station.
6. Repeat steps 3 and 4 to customize each station if desired.
7. Press the **➡** button until you reach the station that you would like watering to begin.
8. Return dial to **AUTOMATIC** (program will water the entire program beginning with the station number last left in the display, then controller will return to automatic mode with no change in the previously set program).









**NOTE: The station that is on the display when you turn the dial to AUTOMATIC will be the first station to run. The controller will then proceed to water in sequential order only. It will not water previous stations. Example: If you turn the dial to AUTOMATIC with the display reading station 3, the controller will water stations 3 through 6 in the program, but not return to stations 1 and 2.**

# PROGRAMMING THE CONTROLLER (continued) .....

## One Touch Manual Start and Advance

You can also activate all stations to water without using the dial.

1. Hold down the  button for 2 seconds.
2. This feature automatically defaults to program A. You can select program B or C by pressing the  program.
3. The station number will be flashing. Press the  button to scroll through the stations and use the  or  button to adjust the station run times. (If no buttons are pressed for a few seconds during step 2 or 3, the controller will automatically begin watering.)
4. Press the  button to scroll to the station you wish to begin with. After a 2 second pause, the program will begin.

This feature is great for a quick cycle when extra watering is needed or if you would like to scroll through the stations to inspect your system.

## **TROUBLESHOOTING GUIDE .....**

<b>PROBLEM</b>	<b>CAUSES</b>	<b>SOLUTIONS</b>
<b>Display indicates watering but none is occurring.</b>	Faulty or miswired valve. Faulty pump or pump relay. No water pressure to system.	Check valve and valve wiring. Check pump and pump relay. Replace if defective. Turn on main system water supply.
<b>Display is blank.</b>	No AC power reaching controller.	Verify AC power and wiring. Correct any errors. Check transformer output.
<b>Display is blank with AC power to terminal and with a new battery.</b>	Controller may be damaged by power surge.	Call your dealer or Hunter installer.
<b>Time of day display is blinking.</b>	Unit has just been powered up for the first time. Extended power outage has occurred that has drained backup battery.	Set time/date. Replace battery and reprogram controller.
<b>Rain sensor does not suspend irrigation.</b>	Rain sensor is defective or miswired. Jumper not removed.	Verify operation of sensor and proper wiring. Remove jumper.

## **TROUBLESHOOTING GUIDE (continued) .....**

<b>PROBLEM</b>	<b>CAUSES</b>	<b>SOLUTIONS</b>
<b>Automatic irrigation does not start at start time and controller is not in the system off mode.</b>	AM/PM of time of day not set correctly. AM/PM of start time not set correctly. Start time is disabled (Set for Off). Rain Sensor is preventing operation. Controller is not receiving AC power.	Correct AM/PM of time of day. Correct AM/PM of start time. Turn dial to Automatic.  Check AC connections.
<b>Valve will not turn on.</b>	Short in wire connections.  Bad solenoid.	Check wiring for short or faulty wire connections.  Replace solenoid.
<b>Controller waters the same area more than one time.</b>	Too many start times entered in program.	One start time activates a complete cycle. See "Setting Start Times."
<b>Display shows "ERR" with a number (1-6).</b>	Short in valve wiring circuit; or a faulty solenoid on the station number indicated.	Check wire circuit or solenoid for the valve number indicated. Repair short or replace solenoid. Press any button to clear "ERR" display.

# FREQUENTLY ASKED QUESTIONS .....

**1. WHY DOES MY SYSTEM CONTINUE TO CYCLE THROUGH OVER AND OVER?**

You may have too many start times entered. Only one start time is needed to run a program. See section titled “Start Times.”

**2. DO I NEED A START TIME FOR EVERY STATION?**

No! You only need one start time per program. The program runs sequentially, so the proceeding station will automatically start when the previous station is finished, no need for additional start times. Multiple start times are utilized when you desire to water an entire program more that once in a 24-hour period.

**3. WHY ARE THERE THREE DIFFERENT PROGRAMS (A, B, AND C)?**

These three programs exist for a variety of reasons. Since customers needs vary from each location, it is important to make sure that even the largest landscapes can be properly irrigated. Most consumers can fulfill their needs with a single program and a single start time, but others who have a variety of different plant life may need more than one program and several start times. See the section “Programming Fundamentals” for more information.

**4. WHAT ARE THE DIFFERENCES BETWEEN PROGRAMS A, B AND C?**

They all have the same features and functions. Three programs give you the option to have several different types of plants watered at different days and times. See “Programming Fundamentals” for more information.

**5. WHY IS THE ♠ ON DAY 1 EVERY TIME I TURN THE DIAL TO “WATER DAYS”?**

The ♠ always flashes on day 1 when you turn the dial to this position. When finished setting the days you want, turn the dial to any position. When you go back to WATER DAYS you will see the ♠ lit over the days you have chosen.

**6. AN INDIVIDUAL STATION WON’T SHUT OFF. WHAT DO I DO?**

When one particular station is stuck on, you want to shut off the controller by turning the dial to the off position. If the station is still running, you will need to shut off the main water supply to the sprinkler system. Most likely there is a valve stuck open, caused by debris in the valve. A loose solenoid or loose valve cap may also be the problem. Check these connections or call your contractor for assistance.

# SPECIFICATIONS

---

## Models

### 230VAC Transformer Version

#### Outdoor Cabinet Types

- EC-401-E: 4 station
- EC-601-E: 6 station
- EC-401-A: 4 station Australian plug
- EC-601-A: 6 station Australian plug

#### Indoor and Line In/Line Out External Transformer

- EC-201i-E: 2 station European plug
- EC-401i-E: 4 station European plug
- EC-601i-E: 6 station European plug
- EC-201i-A: 2 station Australian plug
- EC-401i-A: 4 station Australian plug
- EC-601i-A: 6 station Australian plug

### 110VAC Transformer Version

#### Outdoor Cabinet Types

- EC-400: 4 station
- EC-600: 6 station

#### Indoor and US Plug-in Transformer

- EC-200i: 2 station
- EC-400i: 4 station
- EC-600i: 6 station

## Operating Specifications

- Station Run Time: 0 to 4 hours in 1-minute increments
- Start Times: 4 per day, per program, for up to 12 daily starts
- Watering Schedule: 7-day calendar or interval (1 to 31 day) programming
- AM/PM or 24 hour clock option
- Start time stacking
- Simple manual operation, including 1 button manual operation
- Seasonal Adjustment: 10 to 150% in 10% increments

## Electrical Specifications

- Transformer Input: 230VAC, 50Hz International Use
- Transformer Output: 240VAC, 0.600 amps
- Station Output: 24VAC, .28 amps per station
- Maximum Output: 24VAC, .56 amps
- Master Valve Output: 24VAC, .28 amps
- Battery: Not required for program backup. 9-volt alkaline battery (not included) may be used to program controller in absence of AC power.
- Electronic short circuit protection
- Surge protection: primary MOV-type
- Non-volatile memory for program data
- Controller will track time for 4 weeks in event of a power outage (even without a 9 volt battery)
- Rain sensor override by manual operation
- Three Programs: A, B and C

## **Dimensions**

- Indoor model: 13.3 cm H x 14.6 cm W x 5 cm D
- Outdoor model: 22 cm H x 17.8 cm W x 9.5 cm D

## **Default Settings**

All stations are set to zero run time. The controller has a non-volatile memory that retains all entered program data even during power outages.





# QUICK PROGRAMMING GUIDE

## Setting the Date and Time

1. Turn the dial to the **CURRENT TIME/DAY** position.
2. Hours will be flashing. Press the **+** or **-** button to change the hour shown on the display. Press the **➡** to proceed to setting the minutes.
3. Minutes will be flashing. Use the **+** or **-** button to change the minutes shown on the display. Press the **➡** to proceed to select AM, PM, or 24 hour time.
4. The time will be displayed, and an arrow will be flashing on AM. Press the **+** and **-** buttons to select AM, PM, or 24 hour. Press the **➡** to proceed to setting the day of the week.
5. The number one will be flashing indicating the first day of the week. Press the **+** and **-** buttons to select the day of the week (1 through 7) corresponding to the day.

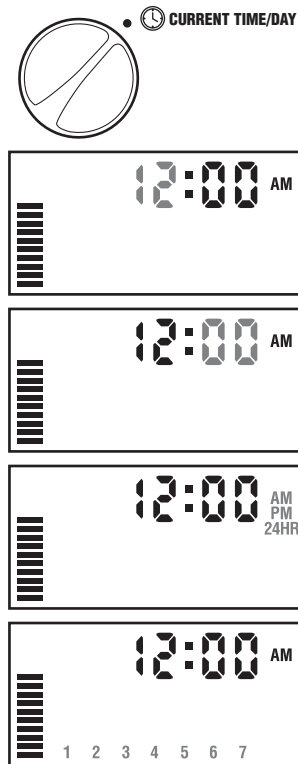

## Setting Watering Start Times

1. Turn the dial to the **START TIMES** position.
2. The factory preset is set on program A. If necessary, you can select program B or C by pressing the **PRG** button.
3. Use the **+** or **-** button to change the start time. (The start times advance in 15 minute increments). Hold either button down for 1 second to change times rapidly.
4. Press the **➡** button to select the next start time, or press **PRG** for the next program.

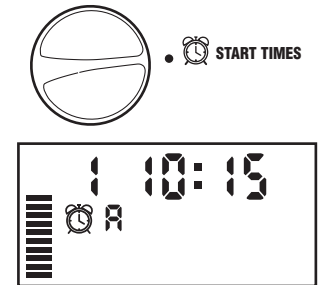

**NOTE:** One start time will activate all stations sequentially in that program. This eliminates the need to enter each station's start time. Multiple start times in a program can be used for separate morning, afternoon, or evening watering cycles.



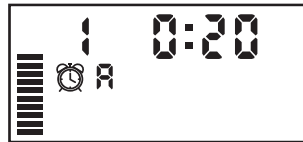

# QUICK PROGRAMMING GUIDE

## Setting Station Run Times (Length of Watering for Each Area)

1. Turn the dial to the **RUN TIMES** position.
2. Use the **+** or **-** button to change the station run time on the display.
3. Press the **→** button to advance to the next station.
4. Repeat steps 3 and 4 for each station.
5. You can set station run times anywhere from 0 to 4 hours.
6. You can move between programs while staying on the same station. However, it is recommended that one program is completed before going on to the next program.





## Setting Days To Water

1. Turn the dial to the **WATER DAYS** position.
2. The controller will display the seven days of the week with a  icon or a  icon above the numbered day. The  icon would represent an "On" water day, while a  icon would represent an "Off" watering day.



## Selecting Specific Days of the Week to Water

1. With the  cursor on a specific day (the cursor always starts with 1), press the **+** button to activate a particular day of the week to water. Press the **-** button to cancel watering for that day. After pressing a button the cursor automatically advances to the next day.
2. Repeat step 1 until all desired days have been selected. The selected days will show with a  to indicate their status as ON. The last  is the last day of watering for that program.



## Selecting Interval Watering

With this option you can select interval watering from 1 to 31 days.

1. With the  cursor on day 7, press the **→** button until the two calendars and a flashing 1 appear in the display. Interval watering schedule appears on the display.
2. Press the **+** or **-** button to select the number of days between watering days (1 to 31). This is called the interval.

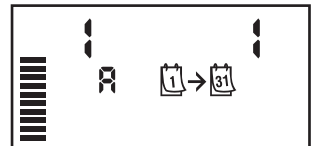

The controller will water the selected program at the next Start Time and will then water at the interval programmed.

## Automatic

After programming is complete, turn the dial to **AUTOMATIC** to enable automatic execution of all selected programs and start times. Watering will not occur unless dial is in the **AUTOMATIC** position.

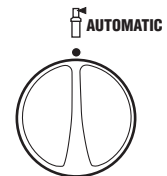

**INFORMATION ABOUT YOUR SPRINKLER SYSTEM .....**

Date of Installation: \_\_\_\_\_

Contractor Installing System: \_\_\_\_\_

Address: \_\_\_\_\_

\_\_\_\_\_

Phone: \_\_\_\_\_

Location of Control Valves: \_\_\_\_\_

\_\_\_\_\_

Location of Weather Sensor: \_\_\_\_\_

\_\_\_\_\_

Location of Main Water Supply Shutoff: \_\_\_\_\_

\_\_\_\_\_

## **FCC NOTICE .....**

This controller generates radio frequency energy and may cause interference to radio and television reception. It has been type tested and found to comply with the limits for a Class B computing device in accordance with the specifications in Subpart J of Part 15 of FCC Rules, which are designed to provide reasonable protection against such interference in a residential installation. However, there is no guarantee that interference will not occur in a particular installation. If this equipment does cause interference to radio or television reception, which can be determined by turning the equipment off and on, the user is encouraged to try to correct the interference by one or more of the following measures:

- Reorient the receiving antenna
- Move the controller away from the receiver
- Plug the controller into a different outlet so that controller and receiver are on different branch circuits

If necessary, the user should consult the dealer or an experienced radio/television technician for additional suggestions. The user may find the following booklet prepared by the Federal Communications Commission helpful: "How to Identify and Resolve Radio-TV Interference Problems." This booklet is available from the U.S. Government Printing Office, Washington, D.C., Stock No. 004-000-00345-4 (price – \$2.00 postpaid).

## **CERTIFICATE OF CONFORMITY TO EUROPEAN DIRECTIVES .....**

Hunter Industries declares that the irrigation controller Model EC complies with the standards of the European Directives of "electromagnetic compatibility" 87/336/EEC and "low voltage" 73/23/EEC.

  
Project Engineer



---

### **Hunter Industries Incorporated • The Irrigation Innovators**

U.S.A.: 1940 Diamond Street • San Marcos, California 92069 • TEL: (1) 760-744-5240 • FAX: (1) 760-744-7461 • [www.HunterIndustries.com](http://www.HunterIndustries.com)  
Australia: 8 The Parade West • Kent Town, S. Australia 5067 • TEL: (61) 8-8363-3599 • FAX: (61) 8-8363-3687  
Europe: Europarc, Bât. B14 • 1330, rue G. de la Lauzières • 13855 Aix-en-Provence, France • TEL: (33) 4-42-93-03-68 • FAX: (33) 4-42-93-03-84

© 2001 Hunter Industries Incorporated

P/N 700661  
INT-417.PDF

5/01